

AXIS

Tools for **m**ICRO **m**ACHINING

Schneidenecke
Corner

Wirkungswinkel η
Resultant cutting speed angle η

Schnittrichtung
Cutting direction

Wirkrichtung
Direction of cutting motion

Vorschub S
Feed S

Schnittweg je Umdrehung = $d \cdot \pi$
Cutting travel per revolution = $d \cdot \pi$

Vorschubrichtung
Feed direction



KATALOG 14

www.axis-europe.eu / www.axis-microtools.com

mODERNE FERTIGUNG FÜR INNOVATIVE WERKZEUGE
mODERN PRODUCTION OF INNOVATIVE TOOLS
fABRICATION MODERNE POUR DES OUTILS INNOVATEURS



Wir produzieren seit über 25 Jahren hochpräzise Werkzeuge für die Mikrozerspannung und die Bohrungseinstbearbeitung, eingesetzt in aller Welt.

Solide und auf qualitative Expansion ausgerichtet, entwickelt sich AXIS zu einem Unternehmen von Weltruf und bringt immer wieder neueste Technologie auf den Markt.

Unsere besondere Stärke liegt bei der Herstellung von Mikrowerkzeugen mit höchsten Genauigkeiten bei Durchmesser, Rundlauf und Radien.



For more than 25 years, we have been producing tools for micro machining and for borehole machining employed in many production processes worldwide.

With a solid base and focus on quality expansion, AXIS has steadily developed and constantly introduced new technologies in the market.

Our particular strength is in manufacturing tools with the highest degree of accuracy in diameter, concentricity and radii.



Nous produisons plus de 25 ans outils de haute précision pour utilisés dans de nombreux procédés de production dans le monde entier.

L'entreprise continue toujours d'apporter les toutes nouvelles technologies sur le marché.

Notre force particulière se situe dans la fabrication de mico-outillages avec des précisions extrêmes en termes de diamètre, concentricité et rayons.

Schneidrichtung
Cutting direction

Wirkrichtung
Direction

Vorschub S
Feed

chneidweg je Umdrehung = $d \cdot \pi$
cutting travel per revolution = $d \cdot \pi$

Werkrichtung
direction



mODERNE BESCHICHTUNG FÜR INNOVATIVE WERKZEUGE mODERN COATING FOR INNOVATIVE TOOLS rEVÊTEMENT MODERNE POUR DES OUTILS INNOVATEURS



AXIS Produkte sind Spezialwerkzeuge für sehr viele Applikationen, speziell auch für die Hochgeschwindigkeits-Zerspanung in Branchen wie dem Flugzeug- und Automobilbau, in der Medizintechnik, in der Optik, Uhren-, Schmuck-Industrie sowie auch in allen elektronischen und feinmechanischen Bereichen.

AXIS kann durch neueste Technologien und Maschinen seinen Kunden ein komplettes Portfolio an VHM-Werkzeugen anbieten, welches den Anforderungen der heutigen fortgeschrittenen Technik entspricht.

Ebenso verfügt **AXIS** über eine eigene Beschichtungsanlage von CEMECON.



AXIS products are typically used for high-precision mechanical applications in the following fields: aerospace, medical, optics, jewellery, watch making, electronic components, automotive and so on.

With the purchase of new, modern equipment and machineries, **AXIS** can offer its customers a complete range of solid carbide tools that can meet the present requirements of the most advanced production techniques.

In addition, **AXIS** has its own CEMECON coating plant.



Les outils pour la fabrication mécanique de haute précision, spécifique pour les secteurs aérospatiale, médicale, optique, joaillerie et horlogerie, manufacture des composants électroniques, automobile, font partie des spécifiques applications de produits **AXIS**.

AXIS, grâce à l'acquisition d'équipements et de machineries à l'avantgarde, est en mesure d'offrir à sa clientèle une gamme complète d'outils en métal dur intégrale capable de satisfaire au mieux les exigences actuelles imposées par les plus avancés techniques de production.

Les revêtements sont produits par **AXIS** lui-même. Système de revêtement provient d'CEMECON



aNWENDUNGSBEREICH
aPPPLICATION
uTILISATION



Auf jeder Produktseite finden Sie unseren Zerspanungskompass, der Auskunft darüber gibt, für welche Materialien diese spezielle Produktreihe geeignet ist.



Each product page contains our machining guide providing you with information on the materials for which this special product range is suitable.



Chaque page produit reprend notre guide d'usage; celui-ci vous donne des indications sur les matériels adaptés à une gamme de produits spécifiques.



optimal geeignet / first choice / premier choix

geeignet / suitable / approprié

nicht geeignet / not suitable / ne approprié

sYMBOLS
iCONS

sIGNIFICATION DES SYMBOLES

Spitzenwinkel
Point angle
Angle de pointe



Zähnezahl
No of flutes
N° dents



Bohrungstiefe
Depth of drilling
Profondeur de perçage



DIN-Normung
DIN Norm
Normes DIN



Mögliche Bearbeitungsrichtung
Machining direction possibility
Sens d'usinage possible

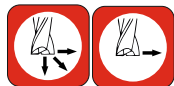

Beschichtung
Coating
Revêtement



Toleranz
Tolerance
Tolérance



Schneidrichtung
Cutting direction
Direction de coupe



Zylindrischer Schaft
Cylindrical shank
Queue cylindrique

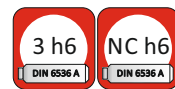

Besonderheit
Special
Spécial



Hochgeschwindigkeit
High speed cutting
Haute vitesse



Anwendungsbereich
Application
Utilisation



sTANDORT
lOCATION
eMPLACEMENT



Vertriebsbüro
und Lager

Sales office
and stock

Distribution
et stock

AXIS Europe GmbH
Weingarten
Süddeutschland

AXIS Europe GmbH
Weingarten
Southern Germany

AXIS Europe GmbH
Weingarten
Sud d'Allemagne



sONDERWERKZEUGE
sPECIAL TOOLS
oUTILS SPÉCIAUX



Ein moderner CNC-Maschinenpark, High-End Mess- und Prüfgeräte sind Garantien für exzellente Präzision. Viele der von uns hergestellten Produkte sind **Sonderwerkzeuge**. Mit Gespür für technische und wirtschaftliche Machbarkeit entwickeln wir individuelle Lösungen für Ihre Bearbeitungsprobleme.



Modern CNC machines, high-end measuring and inspection equipment guarantee the perfection of our tools. Many of our products are **special tools**. With a sure sense for what is technically and economically feasible, we develop individualized solutions for your specific application.



Un parc de machines CN modernes, un technologie de métrologie et de contrôle des plus avancées et une collaboration étroite sont les garants d'une perfection excellente de nos outils. Un grand nombre de notre fabrication sont constitués **d'outils spéciaux**. Avec une appréciation certaine de la faisabilité technique et économique, nous développons des solutions particulières pour vos applications spécifiques.

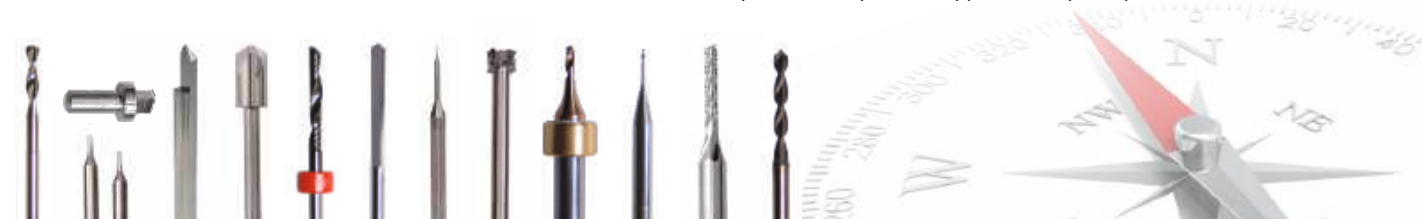

STANDARDPROGRAMM
STANDARD RANGE
PROGRAMME STANDARD

zentrieren
centering
centrage



Seite/Page
08

bohren
drilling
perçage



Seite/Page
08/09

HPC-bohren
HPC-drilling
HPC-perçage



Seite/Page
29

fräsen z=1
milling z=1
fraisage z=1



Seite/Page
41

fräsen z=2
milling z=2
fraisage z=2



Seite/Page
53

fräsen z=3/4
milling z=3/4
fraisage z=3/4



Seite/Page
61

fräsen z=2/4
milling z=2/4
fraisage z=2/4



Seite/Page
67

fräsen CFK/GFK
milling CFRP
fraisage PRFC/PRFV



Seite/Page
74/75



STANDARDPROGRAMM
STANDARD RANGE
PROGRAMME STANDARD

gewinden
thread cutting
taroudage



Seite/Page
85

entgraten
deburring
ébavurage



Seite/Page
85

senken
countersinking
chanfrainage



Seite/Page
90

gravieren
engraving
gravure



Seite/Page
90

dENTAL WERKZEUGE
dENTAL TOOLS
oUTILS DENTAIRES

auf Anfrage
on request
sur demande



sONDERWERKZEUGE
sPECIAL TOOLS
oUTILS SPÉCIAUX



auf Anfrage
on request
sur demande



dER WEG ZUM RICHTIGEN WERKZEUG (KOMPASS)
tHE WAY TO THE RIGHT TOOL (COMPASS)
cHOISIR LE BON OUTIL (COMPASS)





zentrieren	centering	centrage	∅		Seite / Page
VHM-Zentrierbohrer nach DIN 333	SC centre drills as per DIN 333	Foret à centrer en carbure dimensions selon DIN 333	0,50 – 6,30		10
VHM-NC-Anbohrer	SC NC-spotting-drills	Foret à pointer en carbure	2,00 – 10,00		11
VHM-Micro-Pilotbohrer	SC NC-pointing-drills	Micro-Foret piloté en carbure	0,05 – 3,00		12

bohren	drilling	perçage	∅		Seite / Page
VHM-Spiralbohrer ähnlich DIN 1897/6539	SC parallel shank drills similar DIN 1897/6539	Foret hélicoïdal en carbure similaire DIN 1897/6539	0,30 – 10,00		13
VHM-Spiralbohrer ähnlich DIN 338	SC parallel shank drills similar DIN 338	Foret hélicoïdal en carbure similaire DIN 338	0,50 – 12,00		16

VHM-Micro-Bohrer, kurz mit verstärktem Schaft (1,0 / 1,5)	SC micro drills with reinforced shank (1,0 / 1,5)	Micro-foret hélicoïdal en carbure avec manche renforcé (1,0 / 1,5)	0,05 – 1,50		18
VHM-Micro-Bohrer (Inverse) verstärkter Schaft 3,00 mm	SC micro drills (Inverse) with reinforced shank 3,00 mm	Micro-foret hélicoïdal (Inverse) en carbure avec manche renforcé 3,00 mm	0,20 – 6,50		20



bohren	drilling	perçage	∅		Seite / Page
VHM-Micro-Bohrer mit verstärktem Schaft 3,0 mm	SC micro drills with reinforced shank 3,0 mm	Micro-foret hélicoïdal en carbure avec manche renforcé 3,0 mm	0,03 – 3,00		22
VHM-Micro-Bohrer HPC mit verstärktem Schaft 3,0 mm TiAlN beschichtet	SC micro drills HPC with reinforced shank 3,0 mm TiAlN coated	Micro-foret hélicoïdal HPC en carbure avec manche renforcé 3,0 mm Revêtement: TiAlN	0,10 – 3,00		24
VHM-Bohrer mit verstärktem Schaft 6,0 mm unbeschichtet	SC drills with reinforced shank 6,0 mm uncoated	Foret hélicoïdal en carbure avec manche renforcé 6,0 mm Revêtement: -/-	3,00 – 6,00		26
VHM-Bohrer mit verstärktem Schaft 6,0 mm nACo – beschichtet	SC drills with reinforced shank 6,0 mm nACo – coated	Foret hélicoïdal en carbure avec manche renforcé 6,0 mm Revêtement: nACo	3,00 – 6,00		26
VHM-Bohrer mit verstärktem Schaft 6,0 mm DLC – beschichtet	SC drills with reinforced shank 6,0 mm DLC – coated	Foret hélicoïdal en carbure avec manche renforcé 6,0 mm Revêtement: DLC	3,00 – 6,00		26
VHM-Spitzbohrer (Spatenbohrer) mit verstärktem Schaft	Solid carbide spade drills with reinforced shank	Forets plats en carbure avec manche renforcé	0,30 – 6,00 l/r g/d		27
VHM-Kanonenbohrer (Halbrundbohrer) mit verstärktem Schaft	Solid carbide half moon drills with reinforced shank	Forets plats en carbure avec manche renforcé	0,30 – 6,00		28



AXIS
Tools for **mICRO mACHINING**

T5701

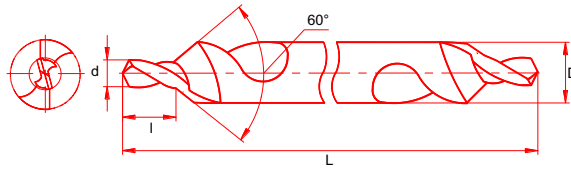

VHM-Zentrierbohrer nach DIN 333

2 Schneiden
rechtsschneidend

Drallwinkel: 30°
doppelseitig: 60°

Anschnitt: 4 Flächen

Form A

SC centre drills as per DIN 333

2 flutes
right-hand cutting

Helix angle: 30°
double-sided: 60°

Point : 4 facet pointing

form A

Foret à centrer en carbure dimensions selon DIN 333

2 dents
coupe à droite

Angle d'hélice: 30°
60° sur les deux cotés

Affûtage: 4 facettes

forme A

Your Partner in **mICRO mACHINING**

www.axis-europe.eu
www.axis-microtools.com

QMS ISO 9001:2008

Ø d	l	L	D	
0,50	0,60 - 0,90	25,00	3,15	
0,80	1,00 - 1,30	25,00	3,15	
1,00	1,30 - 1,70	31,50	3,15	
1,00	1,30 - 1,70	35,50	4,00	
1,25	1,60 - 2,00	31,50	3,15	
1,50	2,00 - 2,60	40,00	5,00	
1,60	2,00 - 2,60	35,50	4,00	
2,00	2,50 - 3,10	40,00	5,00	
2,00	2,50 - 3,10	45,00	6,00	
2,50	3,10 - 3,80	45,00	6,30	
2,50	3,10 - 3,80	50,00	8,00	
3,00	3,90 - 4,60	50,00	8,00	
3,00	3,90 - 4,60	55,00	10,00	
3,15	3,90 - 4,60	50,00	8,00	
4,00	5,00 - 5,90	56,00	10,00	
5,00	6,30 - 7,20	63,00	12,00	
5,00	6,30 - 7,20	63,00	12,50	
6,30	8,00 - 8,90	71,00	16,00	

() kurzfristig lieferbar

() delivery on short notice

() livraison sous court délai

- DIN 333 Form R (mit Radius) auf Anfrage
- DIN 333 form R (with radius) on request
- DIN 333 forme R (avec rayon) sur demande



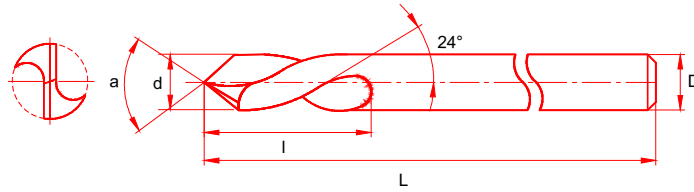

VHM-NC-Anbohrer

2 Schneiden
rechtsschneidend
linksschneidend

Drallwinkel: 24°
Spitzenwinkel: 60° / 90° / 120°

Anschnitt: 4 Flächen

Mit Beschichtung erhältlich

SC NC-spotting-drills

2 flutes
right-hand cutting
left-hand cutting

Helix angle: 24°
Point angle: 60° / 90° / 120°

Point : 4 facet pointing

Available with coating

Foret à pointer en carbure

2 dents
coupe à droite
coupe à gauche

Angle d'hélice: 24°
Angle de pointe: 60° / 90° / 120°

Affûtage: 4 facettes

Disponible avec revêtement

Your Partner in MICRO MACHINING

www.axis-europe.eu
www.axis-microtools.com

QMS ISO 9001:2008

Ø d h6	l	L	D h6	T4901 (R)	T4911 (R)	T4921 (R)		
				T4801 (L)	T4811 (L)	T4821 (L)		
2,00	8,00	40,00	2,00	60°				
					90°			
						120°		
3,00	12,00	50,00	3,00	60°				
					90°			
						120°		
4,00	14,00	50,00	4,00	60°				
					90°			
						120°		
5,00	16,00	60,00	5,00	60°				
					90°			
						120°		
6,00	16,00	60,00	6,00	60°				
					90°			
						120°		
8,00	25,00	60,00	8,00	60°				
					90°			
						120°		
10,00	27,00	70,00	10,00	60°				
					90°			
						120°		

• **Verwendung: / Application: / Utilisation:**

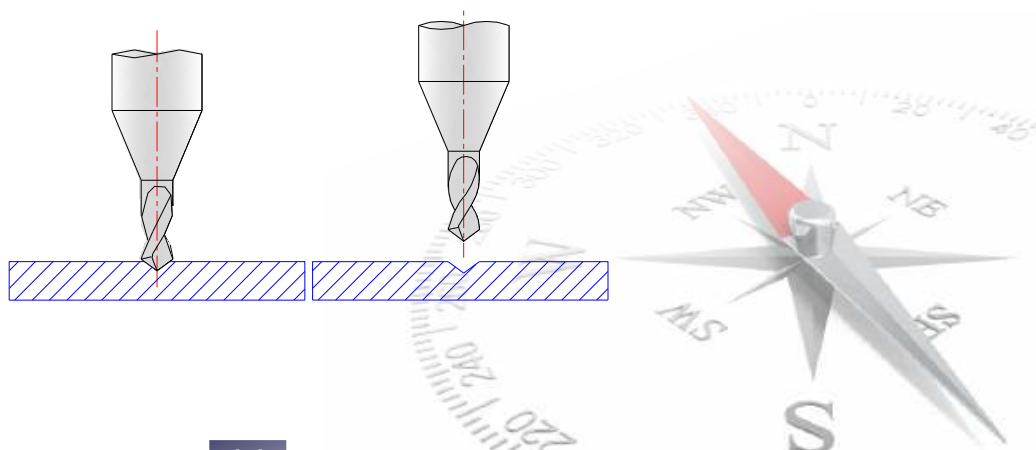

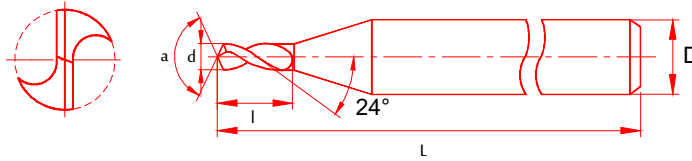

VHM-Micro-Pilotbohrer

2 Schneiden
rechtsschneidend

Drallwinkel: 24°
Spitzenwinkel: 90° / 120° / 142°

Anschnitt: 4 Flächen

Mit Beschichtung erhältlich

SC NC-pointing-drills

2 flutes
right-hand cutting

Helix angle: 24°
Point angle: 90° / 120° / 142°

Point : 4 facet pointing

Available with coating

Micro-Foret piloté en carbure

2 dents
coupe à droite

Angle d'hélice: 24°
Angle de pointe: 90° / 120° / 142°

Affûtage: 4 facettes

Disponible avec revêtement

Your Partner in MICRO MACHINING

www.axis-europe.eu
www.axis-microtools.com

QMS ISO 9001:2008

Ø d	l	L	D h6	T5811 a	T5801 a	T1801 a						
0,05	0,10	38,00	3,00	90°	120°	-						
0,06												
0,07												
0,08												
0,09												
0,10	0,20	38,00	3,00	90°	120°	-						
0,15												
0,20												
0,25												
0,30	0,60	38,00	3,00	90°	120°	-						
0,35												
0,40												
0,45												
0,50												
0,55							1,00	38,00	3,00	90°	120°	142°
0,60												
0,65												
0,70	1,20	38,00	3,00	90°	120°	142°						
0,75												
0,80												
0,85												
0,90												
0,95							1,80	38,00	3,00	90°	120°	142°
1,00												
1,50	2,50	38,00	3,00	90°	120°	142°						
2,00												
2,50							5,50	38,00	3,00	90°	120°	142°
3,00												

Toleranzen: / Tolerances: / Tolérances:

90° / 120°
Ø 0,05 – 0,09 = -5µ / -10µ
Ø ≥ 0,10 = -10µ / -15µ

142°
Ø ≥ 0,50 = h6



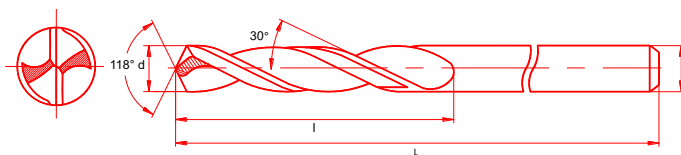

**VHM-Spiralbohrer
ähnlich DIN 1897 / 6539**

2 Schneiden
rechtsschneidend

Drallwinkel: 30°
Spitzenwinkel: 118°

Anschnitt: 4 Flächen

Ø 0,50 – 6,00 mm
Verpackungseinheit: 5 Stück

**SC parallel shank drills
similar DIN 1897 / 6539**

2 flutes
right-hand cutting

Helix angle: 30°
Point angle: 118°

Point : 4 facet pointing

Ø 0,50 – 6,00 mm
Packing unit: 5 pieces

**Foret hélicoïdal en carbure
similaire DIN 1897/6539**

2 dents
coupe à droite

Angle d'hélice: 30°
Angle de pointe: 118°

Affûtage: 4 facettes

Ø 0,50 – 6,00 mm
Conditionnement par 5.

Your Partner in mICRO mACHINING

www.axis-europe.eu
www.axis-microtools.com

QMS ISO 9001:2008

Ø d h6	l	L	D h6
0,30	4,00	30,00	0,30
0,35			0,35
0,40	6,00	30,00	0,40
0,45			0,45
0,50			0,50
0,60			0,60
0,65			0,65
0,70			0,70
0,75	8,00	30,00	0,75
0,80			0,80
0,85			0,85
0,90	9,00	30,00	0,90
0,95			0,95
1,00	10,00	30,00	1,00
1,05			1,05
1,10			1,10
1,15			1,15
1,20			1,20
1,25			1,25
1,30	12,00	30,00	1,30
1,35			1,35
1,40			1,40
1,45			1,45
1,50			1,50
1,55			1,55
1,60	16,00	40,00	1,60
1,65			1,65
1,70			1,70
1,75			1,75
1,80			1,80
1,85			1,85
1,90	19,00	40,00	1,90
1,95			1,95

Ø d h6	l	L	D h6	
2,00	18,00	50,00	2,00	
2,05				
2,10				
2,15				
2,20				
2,25				
2,30				
2,35				
2,40				
2,45				
2,50				
2,55				
2,60				
2,65				
2,70			20,00	50,00
2,75				
2,80				
2,85				
2,90				
2,95				
3,00				
3,05	22,00	50,00	3,05	
3,10				
3,15				
3,20				
3,25				
3,30				
3,35				
3,40				
3,45				
3,50				
3,55				
3,60				
3,65				
3,70				
3,75				
3,80				
3,85				
3,90				
3,95				
4,00				
4,05	25,00	50,00	4,05	
4,10			4,10	

Ø d h6	l	L	D h6			
4,15	25,00	60,00	4,15			
4,20						
4,25						
4,30						
4,35						
4,40						
4,45						
4,50						
4,55						
4,60						
4,65						
4,70						
4,75			26,00	60,00	4,75	
4,80						
4,85						
4,90						
4,95						
5,00						
5,05	28,00	60,00	5,05			
5,10						
5,15						
5,20						
5,25						
5,30						
5,35						
5,40						
5,45						
5,50						
5,55						
5,60						
5,65						
5,70						
5,75						
5,80						
5,85						
5,90						
5,95						
6,00						
6,10	31,00	70,00	6,10			
6,20						
6,30						
6,40						
6,50						

∅ d h6	l	L	D h6	
6,60	31,00	70,00	6,60	
6,70			6,70	
6,80	34,00	74,00	6,80	
6,90			6,90	
7,00			7,00	
7,10			7,10	
7,20			7,20	
7,30			7,30	
7,40			7,40	
7,50			7,50	
7,60	37,00	79,00	7,60	
7,70			7,70	
7,80			7,80	
7,90			7,90	
8,00			8,00	
8,10			8,10	
8,20			8,20	

∅ d h6	l	L	D h6	
8,30	37,00	79,00	8,30	
8,40			8,40	
8,50			8,50	
8,60	40,00	84,00	8,60	
8,70			8,70	
8,80			8,80	
8,90			8,90	
9,00			9,00	
9,10			9,10	
9,20			9,20	
9,30			9,30	
9,40			9,40	
9,50			9,50	
9,60	43,00	89,00	9,60	
9,70			9,70	
9,80			9,80	
9,90			9,90	
10,00			10,00	

() kurzfristig lieferbar

() delivery on short notice

() livraison sous court délai

- Zwischenabmessungen auf Anfrage - mit TiAlN-Beschichtung erhältlich
- Intermediate sizes on request - available with TiAlN coating
- Dimensions intermédiaires sur demande - disponible avec revêtement TiAlN





AXIS
Tools for **mICRO mACHINING**

T8321

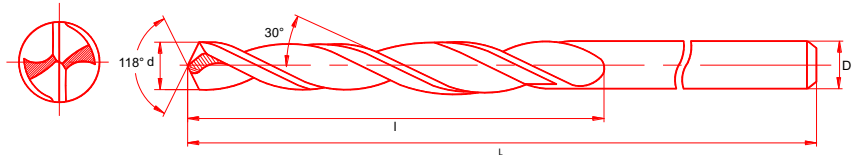
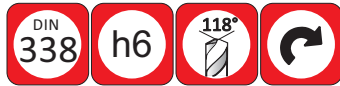

**VHM-Spiralbohrer
ähnlich DIN 338**

2 Schneiden
rechtsschneidend

Drallwinkel: 30°
Spitzenwinkel: 118°

Anschnitt: 4 Flächen

Ø 0,50 – 6,00 mm
Verpackungseinheit: 5 Stück

**SC parallel shank drills
similar DIN 338**

2 flutes
right-hand cutting

Helix angle: 30°
Point angle: 118°

Point : 4 facet pointing

Ø 0,50 – 6,00 mm
Packing unit: 5 pieces

**Foret hélicoïdal en carbure
similaire DIN338**

2 dents
coupe à droite

Angle d'hélice: 30°
Angle de pointe: 118°

Affûtage: 4 facettes

Ø 0,50 – 6,00 mm
Conditionnement par 5.

Your Partner in mICRO mACHINING

www.axis-europe.eu
www.axis-microtools.com

QMS ISO 9001:2008

Ø d h6	l	L	D h6	
0,50	6,00	22,00	0,50	
0,60	7,00	24,00	0,60	
0,70	9,00	28,00	0,70	
0,80	10,00	30,00	0,80	
0,90	11,00	32,00	0,90	
1,00	12,00	34,00	1,00	
1,10	14,00	36,00	1,10	
1,20			1,20	
1,30	16,00	38,00	1,30	
1,40			1,40	
1,50	18,00	40,00	1,50	
1,60			1,60	
1,70	20,00	43,00	1,70	
1,80			1,80	
1,90	22,00	46,00	1,90	
2,00			2,00	
2,10	24,00	49,00	2,10	
2,20			2,20	
2,30	27,00	53,00	2,30	
2,40			2,40	
2,50	30,00	57,00	2,50	
2,60			2,60	
2,70			2,70	
2,80			2,80	
2,90	33,00	61,00	2,90	
3,00			3,00	
3,10			3,10	
3,20	36,00	65,00	3,20	
3,30			3,30	
3,40			3,40	
3,50	39,00	70,00	3,50	
3,60			3,60	
3,70			3,70	

Ø d h6	l	L	D h6			
3,80	43,00	75,00	3,80			
3,90			3,90			
4,00			4,00			
4,10			4,10			
4,20			4,20			
4,30			47,00	80,00	4,30	
4,40	4,40					
4,50	4,50					
4,60	4,60					
4,70	4,70					
4,80	52,00	86,00			4,80	
4,90			4,90			
5,00			5,00			
5,10			5,10			
5,20			5,20			
5,30			57,00	93,00	5,30	
5,40	5,40					
5,50	5,50					
5,60	5,60					
5,70	5,70					
5,80	5,80					
5,90	57,00	93,00	5,90			
6,00			6,00			
6,10			63,00	101,00	6,10	
6,20					6,20	
6,30					6,30	
6,40					6,40	
6,50	6,50					
6,60	6,60					
6,70	69,00	109,00	6,70			
6,80			6,80			
6,90			6,90			
7,00			7,00			
7,10			7,10			

Ø d h6	l	L	D h6			
7,20	69,00	109,00	7,20			
7,30			7,30			
7,40			7,40			
7,50			7,50			
7,60			75,00	117,00	7,60	
7,70					7,70	
7,80	7,80					
7,90	7,90					
8,00	8,00					
8,10	8,10					
8,20	81,00	125,00	8,20			
8,30			8,30			
8,40			8,40			
8,50			8,50			
8,60			87,00	133,00	8,60	
8,70					8,70	
8,80	8,80					
8,90	8,90					
9,00	9,00					
9,10	9,10					
9,20	94,00	142,00	9,20			
9,30			9,30			
9,40			9,40			
9,50			9,50			
9,60			101,00	151,00	9,60	
9,70					9,70	
9,80	9,80					
9,90	9,90					
10,00	10,00					
10,50	10,50					
11,00	101,00	151,00	11,00			
11,50			11,50			
12,00			12,00			

() kurzfristig lieferbar

() delivery on short notice

() livraison sous court délai

- Zwischenabmessungen auf Anfrage - mit TiAIN-Beschichtung erhältlich
- Intermediate sizes on request - available with TiAIN coating
- Dimensions intermédiaires sur demande - disponible avec revêtement TiAIN



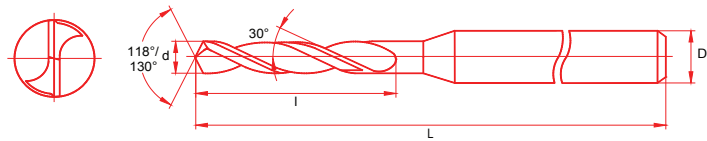

VHM-Micro-Bohrer, kurz mit verstärktem Schaft (1,0 / 1,5)

2 Schneiden rechtsschneidend

Drallwinkel: 30°
Spitzenwinkel: 118° / 130°

Anschnitt: 4 Flächen

Verpackungseinheit: 10 Stück

SC micro drills with reinforced shank (1,0 / 1,5) short

2 flutes right-hand cutting

Helix angle: 30°
Point angle: 118° / 130°

Point : 4 facet pointing

Packing unit: 10 pieces

Micro-foret hélicoïdal en carbure avec manche renforcé (1,0 / 1,5)

2 dents coupe à droite

Angle d'hélice: 30°
Angle de pointe: 118° / 130°

Affûtage: 4 facettes

Conditionnement par 10.

∅ d 0 / -0,004	l	L	D h6
0,05			
0,08			
0,09			
0,10	0,50	25,00	1,00
0,11			
0,12			
0,13			
0,14	0,80	25,00	1,00
0,15			
0,16			
0,17			
0,18	1,10	25,00	1,00
0,19			
0,20			
0,21			
0,22	1,50	25,00	1,00
0,23			
0,24 / 0,245			
0,25 / 0,255			
0,26 / 0,265			
0,27 / 0,275			
0,28 / 0,285	1,90	25,00	1,00
0,29 / 0,295			
0,30 / 0,305			
0,31 / 0,315			
0,32 / 0,325			
0,33 / 0,335			
0,34 / 0,345			
0,35 / 0,355	2,40	25,00	1,00
0,36 / 0,365			
0,37 / 0,375			
0,38 / 0,385			
0,39 / 0,395	2,70	25,00	1,00

Your Partner in MICRO MACHINING

www.axis-europe.eu
www.axis-microtools.com

QMS ISO 9001:2008

$\varnothing d$ 0 / -0,004	l	L	D h6				
0,40 / 0,495	2,70	25,00	1,00				
0,41 / 0,415							
0,42 / 0,425							
0,43 / 0,435							
0,44 / 0,445							
0,45 / 0,455							
0,46 / 0,465							
0,47 / 0,475							
0,48 / 0,485							
0,49 / 0,495							
0,50 / 0,505	3,20	25,00	1,00				
0,51 / 0,515							
0,52 / 0,525							
0,53 / 0,535	3,60	25,00	1,00				
0,54 / 0,545							
0,55 / 0,555							
0,56							
0,57							
0,58							
0,59							
0,60							
0,61				3,90	25,00	1,00	
0,62							
0,63							
0,64							
0,65							
0,66							
0,67							
0,68	4,50	25,00	1,00				
0,69							
0,70							
0,71							
0,72							
0,73							
0,74							
0,75				5,00	25,00	1,00	
0,76							

$\varnothing d$ 0 / -0,004	l	L	D h6	
0,77	5,00	25,00	1,00	
0,78				
0,79				
0,80	5,00	25,00	1,50	
0,81				
0,82				
0,83				
0,84				
0,85				
0,86				5,70
0,87				
0,88				
0,89				
0,90				
0,91				
0,92				
0,93				
0,94				
0,95	6,50	25,00	1,50	
0,96				
0,97				
0,98				
0,99				
1,00				
1,01				
1,02				
1,03	7,30	25,00	1,50	
1,05				
1,10				
1,15				
1,20				8,20
1,25				
1,30	9,20	25,00	1,50	
1,35				
1,40				
1,45				
1,50				

- **Zwischenabmessungen auf Anfrage - mit TiAlN-Beschichtung erhältlich**
- **Intermediate sizes on request - available with TiAlN coating**
- **Dimensions intermédiaires sur demande - disponible avec revêtement TiAlN**



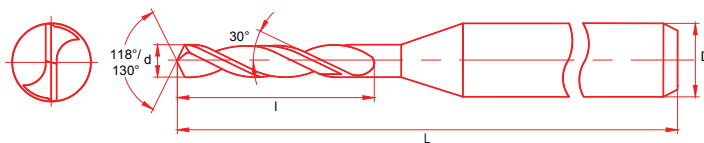

VHM-Micro-Bohrer (Inverse) mit verstärktem Schaft 3,00 mm

2 Schneiden
rechtsschneidend

Drallwinkel: 30°
Spitzenwinkel: 118° / 130° / 165°

Anschnitt: 4 Flächen

Verpackungseinheit: 10 Stück
ab Ø 3,1 mm in Einzelverpackung

SC micro drills (Inverse) with reinforced shank 3,00 mm

2 flutes
right-hand cutting

Helix angle: 30°
Point angle: 118° / 130° / 165°

Point : 4 facet pointing

Packing unit: 10 pieces
from Ø 3,1 mm single packaging

Micro-foret hélicoïdal (Inverse) en carbure avec manche renforcé 3,00 mm

2 dents
coupe à droite

Angle d'hélice: 30°
Angle de pointe: 118° / 130° / 165°

Affûtage: 4 facettes

Conditionnement par 10.
plus Ø 3,0 mm emballage unique

Your Partner in MICRO MACHINING

www.axis-europe.eu
www.axis-microtools.com

QMS ISO 9001:2008

Ø d h6	l	L	D h6
0,20	3,50	38,00	3,00
0,30			
0,40	5,50	38,00	3,00
0,50			
0,60			
0,70	8,50	38,00	3,00
0,80			
0,90			
1,00			
1,10	10,50	38,00	3,00
1,20			
1,30			
1,40			
1,50			
1,60			
1,70			
1,80			
1,90			
2,00			
2,10			
2,20			
2,30			
2,40			
2,50			
2,60			
2,70			
2,80			
2,90			
3,00			
3,10	12,00	38,00	3,00
3,20			
3,30			

Ø d h6	l	L	D h6	
3,40	12,00	38,00	3,00	
3,50				
3,60				
3,70				
3,80				
3,90				
4,00				
4,10				
4,20				
4,30				
4,40				
4,50				
4,60				
4,70				
4,80				
4,90				

Ø d h6	l	L	D h6	
5,00	12,00	38,00	3,00	
5,10				
5,20				
5,30				
5,40				
5,50				
5,60				
5,70				
5,80				
5,90				
6,00				
6,10				
6,20				
6,30				
6,40				
6,50				

- Zwischenabmessungen auf Anfrage - mit TiAlN-Beschichtung erhältlich
- Intermediate sizes on request - available with TiAlN coating
- Dimensions intermédiaires sur demande - disponible avec revêtement TiAlN



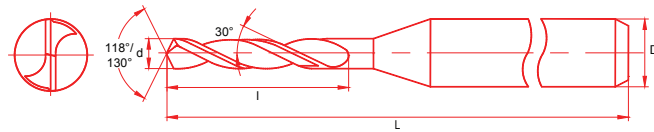

VHM-Micro-Bohrer mit verstärktem Schaft 3,0 mm

2 Schneiden
rechtsschneidend

Drallwinkel: 30°
Spitzenwinkel: 118° / 130°

Anschnitt: 4 Flächen

Verpackungseinheit: 10 Stück

SC micro drills with reinforced shank 3,0 mm

2 flutes
right-hand cutting

Helix angle: 30°
Point angle: 118° / 130°

Point : 4 facet pointing

Packing unit: 10 pieces

Micro-foret hélicoïdal en carbure avec manche renforcé 3,0 mm

2 dents
coupe à droite

Angle d'hélice: 30°
Angle de pointe: 118° / 130°

Affûtage: 4 facettes

Conditionnement par 10.

Your Partner in MICRO MACHINING

www.axis-europe.eu
www.axis-microtools.com

QMS ISO 9001:2008

Ø d h6	l	L	D h6	
0,03	0,30	38,00	3,00	
0,04	0,40	38,00	3,00	
0,05	0,50	38,00	3,00	
0,06	0,60	38,00	3,00	
0,07	0,70	38,00	3,00	
0,08	0,80	38,00	3,00	
0,09	0,90	38,00	3,00	
0,10	1,00	38,00	3,00	
0,11				
0,12				
0,13	1,50	38,00	3,00	
0,14				
0,15				
0,16	2,00	38,00	3,00	
0,17				
0,18				
0,19				
0,20	2,50	38,00	3,00	
0,21				
0,22				
0,23				
0,24				
0,25				
0,26	4,00	38,00	3,00	
0,27				
0,28				
0,29				
0,30				
0,31				
0,32	5,50	38,00	3,00	
0,33				
0,34				

∅ d h6	l	L	D h6
0,35	5,50	38,00	3,00
0,36			
0,37			
0,38			
0,39			
0,40	6,00	38,00	3,00
0,45			
0,50			
0,55	8,00	38,00	3,00
0,60			
0,65			
0,70			
0,75			
0,80			
0,85			
0,90			
0,95			
1,00			
1,05			
1,10			
1,15			
1,20			
1,25			
1,30			
1,35			
1,40			
1,45			
1,50	12,00	38,00	3,00
1,55			

∅ d h6	l	L	D h6
1,60	12,00	38,00	3,00
1,65			
1,70			
1,75			
1,80			
1,85			
1,90			
1,95			
2,00			
2,05			
2,10			
2,15			
2,20			
2,25			
2,30			
2,35			
2,40			
2,45			
2,50			
2,55			
2,60			
2,65			
2,70			
2,75			
2,80			
2,85			
2,90			
2,95			
3,00			

- Zwischenabmessungen auf Anfrage - mit TiAlN-Beschichtung erhältlich
- Intermediate sizes on request - available with TiAlN coating
- Dimensions intermédiaires sur demande - disponible avec revêtement TiAlN





AXIS

Tools for **m**ICRO **m**ACHINING

T6961F

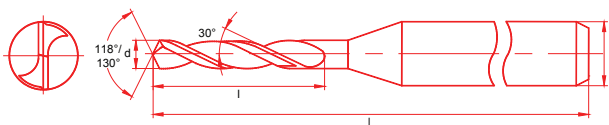

VHM-Micro-Bohrer HPC mit verstärktem Schaft 3,0 mm TiAlN beschichtet

2 Schneiden
rechtsschneidend

Drallwinkel: 30°
Spitzenwinkel: 118° / 130°

Anschnitt: 4 Flächen

SC micro drills HPC with reinforced shank 3,0 mm TiAlN coated

2 flutes
right-hand cutting

Helix angle: 30°
Point angle: 118° / 130°

Point : 4 facet pointing

Micro-foret hélicoïdal HPC en carbure avec manche renforcé 3,0 mm Revêtement : TiAlN

2 dents
coupe à droite

Angle d'hélice: 30°
Angle de pointe: 118° / 130°

Affûtage: 4 facettes

Your Partner in mICRO mACHINING

www.axis-europe.eu
www.axis-microtools.com

QMS ISO 9001:2008

∅ d h6	l	L	D h6	
0,10	1,00	38,00	3,00	
0,15	2,00	38,00	3,00	
0,20	2,50	38,00	3,00	
0,25	4,00	38,00	3,00	
0,30				
0,35	5,50	38,00	3,00	
0,40				
0,45	6,00	38,00	3,00	
0,50				
0,55				
0,60				
0,65				
0,70				
0,75				
0,80	8,00	38,00	3,00	
0,90				
0,95				
0,97				
0,98				
0,99				
1,00				
1,01				
1,02				
1,03				
1,05				
1,10	10,00	38,00	3,00	
1,15				
1,20				
1,25				
1,30				
1,35				
1,40				

∅ d h6	l	L	D h6
1,45	10,00	38,00	3,00
1,47			
1,48			
1,49			
1,50	12,00	38,00	3,00
1,51			
1,52			
1,53			
1,55			
1,60			
1,65			
1,70			
1,75			
1,80			
1,90			
1,95			
1,97			
1,98			
1,99			
2,00			
2,01			
2,02			
2,03			
2,05			
2,10			

∅ d h6	l	L	D h6
2,15	12,00	38,00	3,00
2,20			
2,25			
2,30			
2,35			
2,40			
2,45			
2,50			
2,51			
2,52			
2,53			
2,55			
2,60			
2,65			
2,70			
2,75			
2,80			
2,85			
2,90			
2,95			
2,96			
2,97			
2,98			
2,99			
3,00			

- Zwischenabmessungen auf Anfrage
- Intermediate sizes on request
- Dimensions intermédiaires sur demande



AXIS

Tools for **m**ICRO **m**ACHINING

T2101

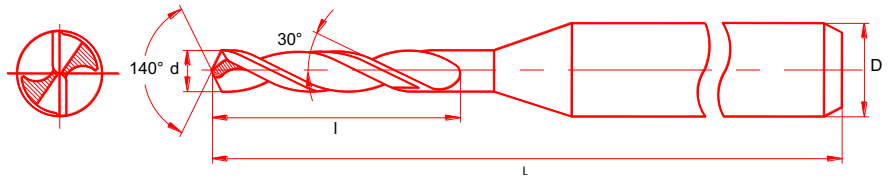
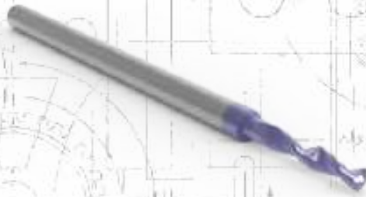

Ø d h6	l	L	D h6
3,00	20,00	60,00	6,00
4,00	24,00	60,00	6,00
5,00	28,00	60,00	6,00
6,00	28,00	60,00	6,00

**VHM-Bohrer
mit verstärktem Schaft 6,0 mm**

T2101: unbeschichtet
T2101N: nAco-beschichtet
T2101C: DLC-beschichtet

2 Schneiden
rechtsschneidend

Drallwinkel: 30°
Spitzenwinkel: 140°

Anschnitt: 4 Flächen

**SC drills with reinforced
shank 6,0 mm**

T2101: uncoated
T2101N: nAco-coated
T2101C: DLC-coated

2 flutes
right-hand cutting

Helix angle: 30°
Point angle: 140°

Point : 4 facet pointing

**Foret hélicoïdal en carbure
avec manche renforcé 6,0 mm**

T2101: revêtement: -/
T2101N: revêtement: nAco
T2101C: revêtement: DLC

2 dents
coupe à droite

Angle d'hélice: 30°
Angle de pointe: 140°

Affûtage: 4 facettes



Ø d h6	l	L	D h6
3,00	20,00	60,00	6,00
4,00	24,00	60,00	6,00
5,00	28,00	60,00	6,00
6,00	28,00	60,00	6,00



Ø d h6	l	L	D h6
3,00	20,00	60,00	6,00
4,00	24,00	60,00	6,00
5,00	28,00	60,00	6,00
6,00	28,00	60,00	6,00

Your Partner in **m**ICRO **m**ACHINING

www.axis-europe.eu
www.axis-microtools.com

QMS ISO 9001:2008



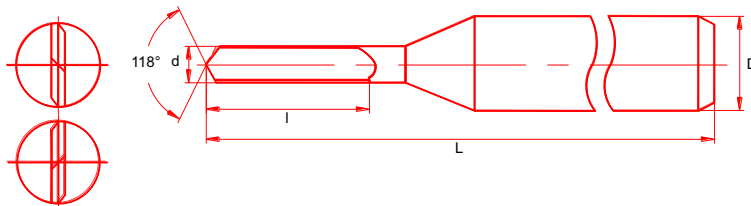

VHM-Spitzbohrer (Spatenbohrer) mit verstärktem Schaft

2 Schneiden

T2001: rechtsschneidend
T2051: linksschneidend

Spitzenwinkel: 118°

Werkzeuge auf Anfrage

Solid carbide spade drills with reinforced shank

2 flutes

T2001: right-hand cutting
T2051: left-hand cutting

Point angle: 118°

Tools on request

Forets plats en carbure avec manche renforcé

2 dents

T2001: coupe à droite
T2051: coupe à gauche

Angle de pointe: 118°

Outil sur demande

Your Partner in MICRO MACHINING

www.axis-europe.eu
www.axis-microtools.com

QMS ISO 9001:2008

Ø d h6	l	L	D h6		
0,30 - 0,39	1,50	30,00	1,00		
0,40 - 0,44	2,00				
0,45 - 0,48	3,60				
0,49 - 0,53	4,00				
0,54 - 0,60	4,50				
0,61 - 0,67	5,00				
0,68 - 0,75	5,60				
0,76 - 0,85	6,30				
0,86 - 0,95	7,10	30,00	1,50		
0,96 - 0,99	8,00				
1,00 - 1,18	9,00				
1,19 - 1,32	10,00				
1,33 - 1,49	11,20				
1,50 - 2,49	12,00				
2,50 - 2,99	15,00				
3,00 - 3,99	18,00				
4,00 - 4,49	20,00	50,00	6,00		
4,50 - 4,99	22,00				
5,00 - 6,00	25,00				

(*) Preis auf Anfrage

(*) Price on request

(*) Prix sur demande



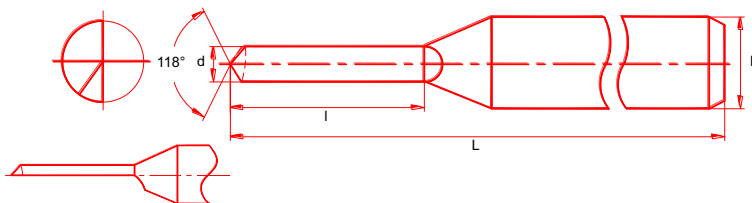

VHM-Kanonenbohrer (Halbrundbohrer) mit verstärktem Schaft

1 Schneide

T9801: rechtsschneidend
T9851: linksschneidend

Spitzenwinkel: 118°

Werkzeuge auf Anfrage

Solid carbide half moon drills with reinforced shank

1 flute

T9801: right-hand cutting
T9851: left-hand cutting

Point angle: 118°

Tools on request

Forets plats (Mèche à canon) en carbure avec manche renforcé

1 dent

T9801: coupe à droite
T9851: coupe à gauche

Angle de pointe: 118°

Outil sur demande

Your Partner in MICRO MACHINING

www.axis-europe.eu
www.axis-microtools.com

QMS ISO 9001:2008

Ø d h6	l	L	D h6		
0,30 - 0,39	1,50	30,00	1,00		
0,40 - 0,44	2,00				
0,45 - 0,48	3,60				
0,49 - 0,53	4,00				
0,54 - 0,60	4,50				
0,61 - 0,67	5,00				
0,68 - 0,75	5,60				
0,76 - 0,85	6,30	30,00	1,50		
0,86 - 0,95	7,10				
0,96 - 0,99	8,00				
1,00 - 1,18	9,00				
1,19 - 1,32	10,00				
1,33 - 1,49	11,20				
1,50 - 2,49	12,00			38,00	2,00
2,50 - 2,99	15,00	38,00	3,00		
3,00 - 3,99	18,00	50,00	4,00		
4,00 - 4,49	20,00	50,00	6,00		
4,50 - 4,99	22,00				
5,00 - 6,00	25,00				





(*) Preis auf Anfrage

(*) Price on request

(*) Prix sur demande





HPC - bohren	HPC - drilling	HPC - perçage	∅		Seite / Page
VHM Micro-Hochleistungsbohrer STEEL 5xD TiAlN beschichtet	SC micro drills HPC STEEL 5xD TiAlN coated	Micro-foret hélicoïdal HPC en carbure STEEL 5xD Revêtement: TiAlN	0,50 – 6,00 INDrill STEEL		30
VHM Micro-Hochleistungsbohrer STEEL 10xD TiAlN beschichtet	SC micro drills HPC STEEL 10xD TiAlN coated	Micro-foret hélicoïdal HPC en carbure STEEL 10xD Revêtement: TiAlN	0,50 – 6,00 INDrill STEEL		32
VHM Micro-Hochleistungsbohrer INOX 5xD TiAlN beschichtet	SC micro drills HPC INOX 5xD TiAlN coated	Micro-foret hélicoïdal HPC en carbure INOX 5xD Revêtement: TiAlN	0,50 – 6,00 INDrill INOX		34
VHM Micro-Hochleistungsbohrer ALU 5xD mit polierter Schneide	SC micro drills HPC ALU 5xD with polished flutes	Micro-foret hélicoïdal HPC en carbure ALU 5xD avec coupes polies	0,50 – 6,00 INDrill ALU		36
VHM Micro-Hochleistungsbohrer CFRP 5xD Diamant beschichtet	SC micro drills HPC CFRP 5xD Diamond coated	Micro-foret hélicoïdal HPC en carbure PRFC/PRFV 5xD Revêtement: Diamant	0,50 – 6,00 INDrill CFRP		38

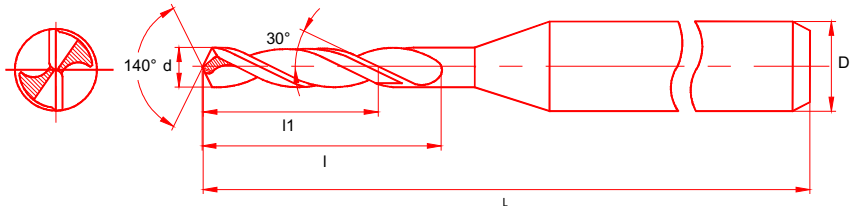

VHM Micro-Hochleistungsbohrer STEEL 5xD TiAlN beschichtet

2 Schneiden rechtsschneidend

Drallwinkel: 30°
Spitzenwinkel: 140°

Anschnitt: 4 Flächen

SC micro drills HPC STEEL 5xD TiAlN coated

2 flutes right-hand cutting

Helix angle: 30°
Point angle: 140°

Point : 4 facet pointing

Micro-foret hélicoïdal HPC en carbure STEEL 5xD Revêtement: TiAlN

2 dents coupe à droite

Angle d'hélice: 30°
Angle de pointe: 140°

Affûtage: 4 facettes

Your Partner in MICRO MACHINING

www.axis-europe.eu
www.axis-microtools.com

QMS ISO 9001:2008

Ø d h6	l1	l	L	D h6
0,50				
0,51-0,59	3,30	4,50	38,00	3,00
0,60				
0,61-0,69				
0,70				
0,71-0,79	4,00	5,50	38,00	3,00
0,80				
0,81-0,89				
0,90				
0,91-0,99	5,00	6,00	38,00	3,00
1,00				
1,01-1,09				
1,10				
1,11-1,19				
1,20				
1,21-1,29	8,00	10,00	38,00	3,00
1,30				
1,31-1,39				
1,40				
1,41-1,49				
1,50				
1,51-1,59				
1,60				
1,61-1,69				
1,70				
1,71-1,79	11,00	14,00	38,00	3,00
1,80				
1,81-1,89				
1,90				
1,91-1,99				

Ø d h6	l1	l	L	D h6
2,00	11,00	14,00	38,00	3,00
2,01-2,09	14,00	18,00	50,00	3,00
2,10				
2,11-2,19				
2,20				
2,21-2,29				
2,30				
2,31-2,39				
2,40				
2,41-2,49				
2,50				
2,51-2,59	16,00	20,00	50,00	3,00
2,60				

Ø d h6	l1	l	L	D h6				
2,61-2,69	16,00	20,00	50,00	3,00				
2,70								
2,71-2,79								
2,80								
2,81-2,89								
2,90								
2,91-2,99								
3,00								
3,01-3,70					23,00	28,00	66,00	4,00
3,71-3,99					29,00	36,00	74,00	4,00
4,00-4,70	6,00							
4,71-6,00	35,00	44,00	82,00	6,00				



() kurzfristig lieferbar

() delivery on short notice

() livraison sous court délai

- Zwischenabmessungen auf Anfrage
- Intermediate sizes on request
- Dimensions intermédiaires sur demande



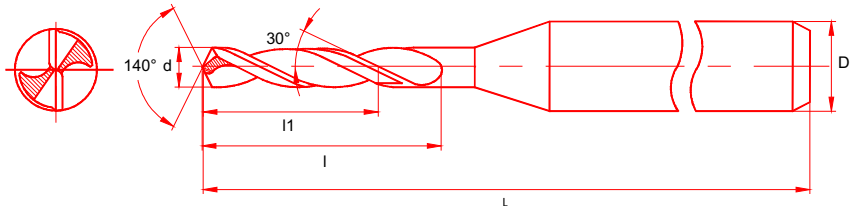

VHM Micro-Hochleistungsbohrer STEEL 10xD TiAlN beschichtet

2 Schneiden rechtsschneidend

Drallwinkel: 30°
Spitzenwinkel: 140°

Anschnitt: 4 Flächen

SC micro drills HPC STEEL 10xD TiAlN coated

2 flutes right-hand cutting

Helix angle: 30°
Point angle: 140°

Point : 4 facet pointing

Micro-foret hélicoïdal HPC en carbure STEEL 10xD Revêtement: TiAlN

2 dents coupe à droite

Angle d'hélice: 30°
Angle de pointe: 140°

Affûtage: 4 facettes

Your Partner in MICRO MACHINING

www.axis-europe.eu
www.axis-microtools.com

QMS ISO 9001:2008

Ø d h6	l1	l	L	D h6	
0,50					
0,51-0,59	6,00	8,00	38,00	3,00	
0,60					
0,61-0,69					
0,70	8,00	10,00	38,00	3,00	
0,71-0,79					
0,80					
0,81-0,89					
0,90	10,00	12,00	38,00	3,00	
0,91-0,99					
1,00					
1,01-1,09					
1,10					
1,11-1,19					
1,20					
1,21-1,29	16,00	20,00	50,00	3,00	
1,30					
1,31-1,39					
1,40					
1,41-1,49					
1,50					
1,51-1,59					
1,60					
1,61-1,69					
1,70					
1,71-1,79	22,00	30,00	66,00	3,00	
1,80					
1,81-1,89					
1,90					
1,91-1,99					

Ø d h6	l1	l	L	D h6	
2,00	22,00	30,00	66,00	3,00	
2,01-2,09	25,00	35,00	74,00	3,00	
2,10					
2,11-2,19					
2,20					
2,21-2,29					
2,30					
2,31-2,39					
2,40					
2,41-2,49					
2,50					
2,51-2,59	32,00	40,00	82,00	3,00	
2,60					

Ø d h6	l1	l	L	D h6					
2,61-2,69	32,00	40,00	82,00	3,00					
2,70									
2,71-2,79									
2,80									
2,81-2,89									
2,90									
2,91-2,99									
3,00									
3,01-3,70					46,00	55,00	95,00	4,00	
3,71-3,99					60,00	72,00	114,00	6,00	4,00
4,00-4,70	6,00								
4,71-6,00	70,00	90,00	142,00	6,00					



() kurzfristig lieferbar

() delivery on short notice

() livraison sous court délai

- Zwischenabmessungen auf Anfrage
- Intermediate sizes on request
- Dimensions intermédiaires sur demande



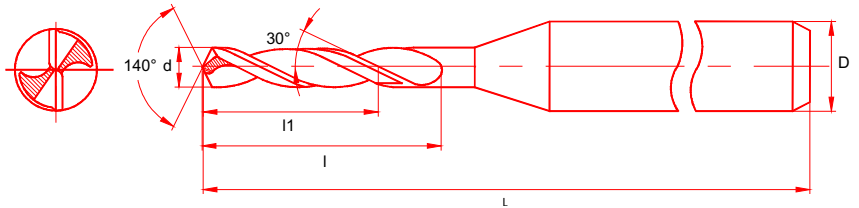

VHM Micro-Hochleistungsbohrer INOX 5xD TiAlN beschichtet

2 Schneiden rechtsschneidend

Drallwinkel: 30°
Spitzenwinkel: 140°

Anschnitt: 4 Flächen

SC micro drills HPC INOX 5xD TiAlN coated

2 flutes right-hand cutting

Helix angle: 30°
Point angle: 140°

Point : 4 facet pointing

Micro-foret hélicoïdal HPC en carbure INOX 5xD Revêtement: TiAlN

2 dents coupe à droite

Angle d'hélice: 30°
Angle de pointe: 140°

Affûtage: 4 facettes

Your Partner in MICRO MACHINING

www.axis-europe.eu
www.axis-microtools.com

QMS ISO 9001:2008

Ø d h6	l1	l	L	D h6
0,50				
0,51-0,59	3,30	4,50	38,00	3,00
0,60				
0,61-0,69				
0,70				
0,71-0,79	4,00	5,50	38,00	3,00
0,80				
0,81-0,89				
0,90				
0,91-0,99	5,00	6,00	38,00	3,00
1,00				
1,01-1,09				
1,10				
1,11-1,19				
1,20				
1,21-1,29				
1,30	8,00	10,00	38,00	3,00
1,31-1,39				
1,40				
1,41-1,49				
1,50				
1,51-1,59				
1,60				
1,61-1,69				
1,70				
1,71-1,79	11,00	14,00	38,00	3,00
1,80				
1,81-1,89				
1,90				
1,91-1,99				

∅ d h6	l1	l	L	D h6
2,00	11,00	14,00	38,00	3,00
2,01-2,09	14,00	18,00	50,00	3,00
2,10				
2,11-2,19				
2,20				
2,21-2,29				
2,30				
2,31-2,39				
2,40				
2,41-2,49				
2,50				
2,51-2,59	16,00	20,00	50,00	3,00
2,60				

∅ d h6	l1	l	L	D h6
2,61-2,69	16,00	20,00	50,00	3,00
2,70				
2,71-2,79				
2,80				
2,81-2,89				
2,90				
2,91-2,99				
3,00	23,00	28,00	66,00	4,00
3,01-3,70	29,00	36,00	74,00	4,00
3,71-3,99				
4,00-4,70				6,00
4,71-6,00				



() kurzfristig lieferbar

() delivery on short notice

() livraison sous court délai

- Zwischenabmessungen auf Anfrage
- Intermediate sizes on request
- Dimensions intermédiaires sur demande



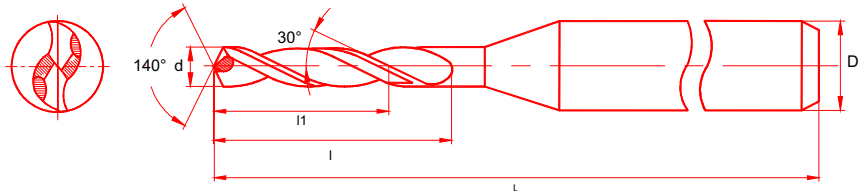

VHM Micro-Hochleistungsbohrer ALU 5xD mit polierter Schneide

2 Schneiden rechtsschneidend

Drallwinkel: 30°
Spitzenwinkel: 140°

Anschnitt: 4 Flächen

SC micro drills HPC ALU 5xD with polished flutes

2 flutes right-hand cutting

Helix angle: 30°
Point angle: 140°

Point : 4 facet pointing

Micro-foret hélicoïdal HPC en carbure ALU 5xD avec coupes polies

2 dents coupe à droite

Angle d'hélice: 30°
Angle de pointe: 140°

Affûtage: 4 facettes

Your Partner in MICRO MACHINING

www.axis-europe.eu
www.axis-microtools.com

QMS ISO 9001:2008

Ø d h6	l1	l	L	D h6
0,50	3,30	4,50	38,00	3,00
0,51-0,59				
0,60				
0,61-0,69	4,00	5,50	38,00	3,00
0,70				
0,71-0,79				
0,80				
0,81-0,89	5,00	6,00	38,00	3,00
0,90				
0,91-0,99				
1,00				
1,01-1,09				
1,10	8,00	10,00	38,00	3,00
1,11-1,19				
1,20				
1,21-1,29				
1,30				
1,31-1,39				
1,40				
1,41-1,49				
1,50				
1,51-1,59				
1,60				
1,61-1,69				
1,70				
1,71-1,79				
1,80				
1,81-1,89				
1,90				
1,91-1,99				

Ø d h6	l1	l	L	D h6	
2,00	11,00	14,00	38,00	3,00	
2,01-2,09	14,00	18,00	50,00	3,00	
2,10					
2,11-2,19					
2,20					
2,21-2,29					
2,30					
2,31-2,39					
2,40					
2,41-2,49					
2,50					
2,51-2,59	16,00	20,00	50,00	3,00	
2,60					

Ø d h6	l1	l	L	D h6					
2,61-2,69	16,00	20,00	50,00	3,00					
2,70									
2,71-2,79									
2,80									
2,81-2,89									
2,90									
2,91-2,99									
3,00					23,00	28,00	66,00	4,00	
3,01-3,70					29,00	36,00	74,00	4,00	
3,71-3,99								6,00	
4,00-4,70									
4,71-6,00	35,00	44,00	82,00	6,00					



() kurzfristig lieferbar

() delivery on short notice

() livraison sous court délai

- Zwischenabmessungen auf Anfrage
- Intermediate sizes on request
- Dimensions intermédiaires sur demande



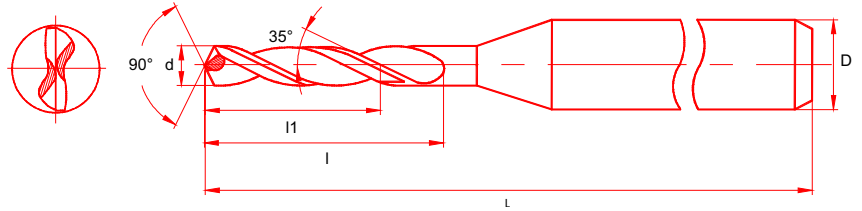

VHM Micro-Hochleistungsbohrer CFRP 5xD
Diamant beschichtet

2 Schneiden
 rechtsschneidend

Drallwinkel: 35°
 Spitzenwinkel: 90°

Anschnitt: 4 Flächen

SC micro drills HPC CFRP 5xD
Diamond coated

2 flutes
 right-hand cutting

Helix angle: 35°
 Point angle: 90°

Point : 4 facet pointing

Micro-foret hélicoïdal HPC en carbure PRFC/PRFV 5xD
Revêtement: Diamant

2 dents
 coupe à droite

Angle d'hélice: 35°
 Angle de pointe: 90°

Affûtage: 4 facettes

Your Partner in MICRO MACHINING

www.axis-europe.eu
www.axis-microtools.com

QMS ISO 9001:2008

Ø d h7	l1	l	L	D h6	
0,50					
0,51-0,59	3,30	4,50	38,00	3,00	
0,60					
0,61-0,69					
0,70	4,00	5,50	38,00	3,00	
0,71-0,79					
0,80					
0,81-0,89					
0,90	5,00	6,00	38,00	3,00	
0,91-0,99					
1,00					
1,01-1,09					
1,10					
1,11-1,19					
1,20					
1,21-1,29	8,00	10,00	38,00	3,00	
1,30					
1,31-1,39					
1,40					
1,41-1,49					
1,50					
1,51-1,59					
1,60					
1,61-1,69					
1,70					
1,71-1,79	11,00	14,00	38,00	3,00	
1,80					
1,81-1,89					
1,90					
1,91-1,99					

Ø d h7	l1	l	L	D h6	
2,00	11,00	14,00	38,00	3,00	
2,01-2,09	14,00	18,00	50,00	3,00	
2,10					
2,11-2,19					
2,20					
2,21-2,29					
2,30					
2,31-2,39					
2,40					
2,41-2,49					
2,50					
2,51-2,59	16,00	20,00	50,00	3,00	
2,60					

Ø d h7	l1	l	L	D h6	
2,61-2,69	16,00	20,00	50,00	3,00	
2,70					
2,71-2,79					
2,80					
2,81-2,89					
2,90					
2,91-2,99					
3,00	23,00	28,00	66,00	4,00	
3,01-3,70	29,00	36,00	74,00	6,00	
3,71-3,99					
4,00-4,70					
4,71-6,00	35,00	44,00	82,00	6,00	



() kurzfristig lieferbar

() delivery on short notice

() livraison sous court délai

- Zwischenabmessungen auf Anfrage
- Intermediate sizes on request
- Dimensions intermédiaires sur demande



HOCHPRÄZISE FRÄSWERKZEUGE HIGH-PRECISION MILLING TOOLS DES OUTILS DE COUPE DE GRANDE PRÉCISION



Wir produzieren seit über 25 Jahren hochpräzise Werkzeuge für die Mikrozerspantung und die Bohrungsfeinstbearbeitung, eingesetzt in aller Welt.

Ein umfangreiches Programm an Fräswerkzeugen liegt ab Lager für Sie bereit. Ausgewählte Hartmetalle und exzellente Präzision garantieren die für Ihren Anwendungsfall optimalen Ergebnisse.



For more than 25 years, we have been producing tools for micro machining and for borehole machining employed in many production processes worldwide.

A comprehensive range of milling tools is available to you directly from stock. Selected tungsten carbides, excellent precision guarantee optimum results for your specific application.



Nous produisons plus de 25 ans outils de haute précision pour utilisés dans de nombreux procédés de production dans le monde entier.

Nous tenons à votre disposition en magasin une vaste gamme d'outils de fraisage. Nous garantissons les meilleurs résultats pour vos applications grâce à la sélection des carbures les mieux adaptés, la précision supérieure de finition et le savoir-faire plus de vingt-cinq années d'expérience.





Z1

fräsen	milling	fraisage	∅		Seite / Page
VHM Einschneidenfräser rechtsschneidend	Solid carbide single flute end mill right-hand cutting	Fraise à une lèvre en carbure coupe à droite	0,10 – 12,00 (RH/RC)		42
VHM Einschneidenfräser rechtsschneidend nACRo beschichtet	Solid carbide single flute end mill right-hand cutting nACRo coated	Fraise à une lèvre en carbure coupe à droite Revêtement: nACRo	0,10 – 12,00 (RH/RC)		44
VHM Einschneidenfräser rechtsschneidend mit polierter Schneide	Solid carbide single flute end mill right-hand cutting with polished flutes	Fraise à une lèvre en carbure coupe à droite avec coupes polies	1,00 – 12,00 (RH/RC)		46
VHM Einschneidenfräser rechtsschneidend Diamant beschichtet	Solid carbide single flute end mill right-hand cutting Diamond coated	Fraise à une lèvre en carbure coupe à droite Revêtement: Diamant	1,00 – 8,00 (RH/RC)		47
VHM Einschneidenfräser rechtsschneidend mit Freischliff	Solid carbide single flute end mill right-hand cutting with ground recess	Fraise à une lèvre en carbure coupe à droite avec degagement	2,00 – 8,00 (RH/RC)		48
VHM Einschneidenfräser Linksdrall	Solid carbide single flute end mill left -hand twist	Fraise à une lèvre en carbure Hélice: droite	1,00 – 8,00 (LH/RC)		49
VHM Einschneidenfräser Linksdrall mit polierter Schneide	Solid carbide single flute end mill left-hand twist with polished flutes	Fraise à une lèvre en carbure Hélice: droite avec coupes polies	1,00 – 12,00 (LH/RC)		50

AXIS

Tools for **m**ICRO **m**ACHINING

E9231

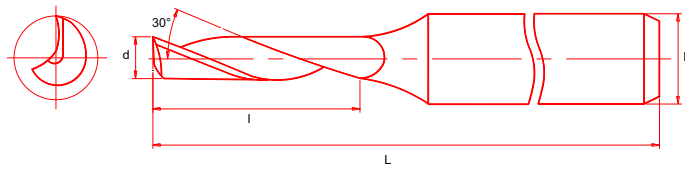
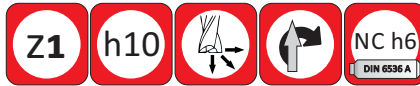
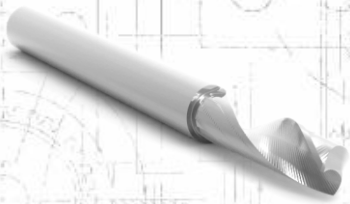

VHM
Einschneidenfräser
(RH/RC)

1 Schneide
 rechtsschneidend, ziehend

Drallwinkel: 30°

Für Aluminium, weiche NE-Metalle und Plastik

Solid carbide
single flute end mill
(RH/RC)

1 flute
 right-hand cutting, up-cut

Helix angle: 30°

For aluminium, soft non-ferrous materials and plastics

Fraise à une lèvre
en carbure (RH/RC)

1 dent
 coupe à droite, cisailage oblique

Angle d'hélice: 30°

Pour aluminium, matériaux non ferreux et plastiques

Your Partner in mICRO mACHINING

www.axis-europe.eu
www.axis-microtools.com

QMS ISO 9001:2008

Ø d	l	L	D h6	
0,10	0,30	38,00	3,00	
0,20	0,60	38,00	3,00	
0,30	1,00	38,00	3,00	
0,40				
0,50	1,50	38,00	3,00	
0,60	3,00	38,00	3,00	
0,70	4,00	38,00	3,00	
0,80				
0,80	5,00	38,00	3,00	
0,90				
1,00	5,00	40,00	6,00	
1,00				
1,20	5,00	38,00	3,00	
1,50				
1,50	5,00	40,00	6,00	
1,60				
1,60	6,00	38,00	3,00	
		40,00	6,00	
1,80	7,00	38,00	3,00	
2,00	5,00	40,00	3,00	
			6,00	
2,00	7,00	40,00	4,00	
			6,00	
2,00	8,00	40,00	3,00	
				10,00
2,40	5,00	40,00	6,00	
2,50	10,00	38,00	3,00	
		40,00		
3,00	5,00	40,00	3,00	
			6,00	
3,00	8,00	40,00	6,00	
3,00	10,00	38,00	3,00	
		40,00		
3,00	10,00	40,00	4,00	

Ø d	l	L	D h6	
3,00	10,00	50,00	6,00	
		60,00	6,00	
3,00	12,00	40,00	3,00	
		50,00	6,00	
4,00	6,00	40,00	4,00	
			6,00	
4,00	10,00	40,00	4,00	
4,00	12,00	50,00	6,00	
		60,00		
4,00	14,00	50,00	4,00	
5,00	7,00	40,00	6,00	
	14,00	50,00		
5,00	14,00	60,00	5,00	

Ø d	l	L	D h6	
5,00	14,00	60,00	6,00	
	16,00		5,00	
6,00	8,00	40,00	6,00	
	14,00	50,00		
6,00	16,00	60,00	6,00	
	20,00			
	25,00			
8,00	14,00	50,00	8,00	
	20,00	60,00		
	25,00	75,00		
	30,00	75,00		
10,00	25,00	75,00	10,00	
12,00	25,00	75,00	12,00	



Beringung auf Anfrage

Ring setting on request

Baguage sur demand

() kurzfristig lieferbar

() delivery on short notice

() livraison sous court délai



AXIS

Tools for **mICRO mACHINING**

E9231N

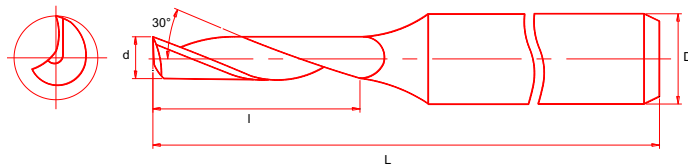

VHM
Einschneidenfräser
(RH/RC)

nACRo beschichtet

1 Schneide
 rechtsschneidend, ziehend

Drallwinkel: 30°

Solid carbide
single flute end mill
(RH/RC)

nACRo coated

1 flute
 right-hand cutting, up-cut

Helix angle: 30°

Fraise à une lèvre
en carbure (RH/RC)

Revêtement: nACRo

1 dent
 coupe à droite, cisailage oblique

Angle d'hélice: 30°

Your Partner in mICRO mACHINING

www.axis-europe.eu
www.axis-microtools.com

QMS ISO 9001:2008

Ø d	l	L	D h6	
0,10	0,30	38,00	3,00	
0,20	0,60	38,00	3,00	
0,30	1,00	38,00	3,00	
0,40				
0,50	1,50	38,00	3,00	
0,60	3,00	38,00	3,00	
0,70	4,00	38,00	3,00	
0,80				
0,80	5,00	38,00	3,00	
0,90				
1,00	5,00	40,00	6,00	
1,20	5,00	38,00	3,00	
1,50	5,00	40,00	6,00	
1,50				
1,60	6,00	38,00	3,00	
		40,00	6,00	
1,80	7,00	38,00	3,00	
2,00	5,00	40,00	3,00	
			6,00	
2,00	7,00	40,00	4,00	
			6,00	
2,00	8,00	40,00	3,00	
	10,00	38,00		
2,40	5,00	40,00	6,00	
2,50	10,00	38,00	3,00	
		40,00		
3,00	5,00	40,00	3,00	
			6,00	
3,00	8,00	40,00	6,00	
3,00	10,00	38,00	3,00	
		40,00		
3,00	10,00	40,00	4,00	

Ø d	l	L	D h6	
3,00	10,00	50,00	6,00	
		60,00	6,00	
3,00	12,00	40,00	3,00	
		50,00	6,00	
4,00	6,00	40,00	4,00	
			6,00	
4,00	10,00	40,00	4,00	
4,00	12,00	50,00	6,00	
		60,00		
4,00	14,00	50,00	4,00	
5,00	7,00	40,00	6,00	
	14,00	50,00		
5,00	14,00	60,00	5,00	

Ø d	l	L	D h6	
5,00	14,00	60,00	6,00	
	16,00		5,00	
6,00	8,00	40,00	6,00	
	14,00	50,00		
6,00	16,00	60,00	6,00	
	20,00			
	25,00			
8,00	14,00	50,00	8,00	
	20,00	60,00		
	25,00	75,00		
	30,00	75,00		
10,00	25,00	75,00	10,00	
12,00	25,00	75,00	12,00	



Beringung auf Anfrage

Ring setting on request

Baguage sur demand

() kurzfristig lieferbar

() delivery on short notice

() livraison sous court délai



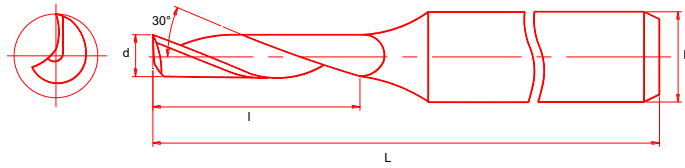
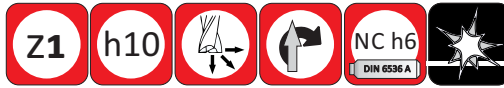

VHM
Einschneidenfräser
(RH/RC)
mit polierter Schneide

1 Schneide
 rechtsschneidend, ziehend

Drallwinkel: 30°

Für Aluminium, weiche NE-Metalle und Plastik

Solid carbide
single flute end mill
(RH/RC)
with polished flutes

1 flute
 right-hand cutting, up-cut

Helix angle: 30°

For aluminium, soft non-ferrous materials and plastics.

Fraise à une lèvre
en carbure
(RH/RC)
avec coupes polies

1 dent
 coupe à droite, cisailage oblique

Angle d'hélice: 30°

Pour aluminium, matériaux non ferreux et plastiques

Your Partner in MICRO MACHINING

www.axis-europe.eu
www.axis-microtools.com

QMS ISO 9001:2008

Ø d	l	L	D h6
1,00	5,00	38,00	3,00
1,50			
2,00	6,00	38,00	3,00
		50,00	6,00
	10,00	38,00	3,00
11,00			
3,00	10,00	38,00	3,00
	11,00		
	22,00	60,00	6,00
4,00	14,00	50,00	4,00
			6,00
5,00	16,00	60,00	6,00
	20,00		
	22,00	50,00	6,00
32,00	64,00		
8,00	20,00	75,00	8,00
	32,00	64,00	
10,00	22,00	64,00	10,00
12,00	22,00	64,00	12,00



Beringung auf Anfrage
 Ring setting on request
 Bagueage sur demand



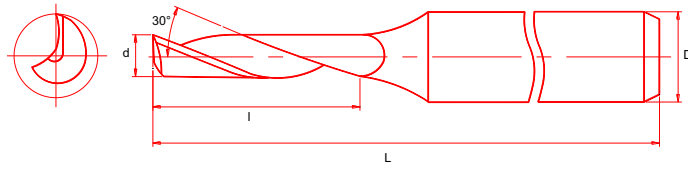
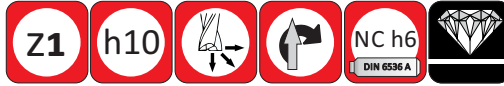

VHM
Einschneidenfräser
(RH/RC)

Diamant beschichtet

1 Schneide
 rechtsschneidend, ziehend

Drallwinkel: 30°

Speziell für abrasive Materialien

Solid carbide
single flute end mill
(RH/RC)

Diamond coated

1 flute
 right-hand cutting, up-cut

Helix angle: 30°

For machining abrasive materials

Fraise à une lèvre
en carbure (RH/RC)

Revêtement: Diamant

1 dent
 coupe à droite, cisailage oblique

Angle d'hélice: 30°

Pour l'usinage de matériaux abrasifs

Your Partner in MICRO MACHINING

www.axis-europe.eu
 www.axis-microtools.com

QMS ISO 9001:2008

Ø d	l	L	D h6
1,00	5,00	38,00	3,00
2,00		40,00	6,00
2,00	10,00	38,00	3,00
3,00	5,00	40,00	6,00
	10,00	38,00	3,00
4,00	14,00	50,00	4,00
	6,00	40,00	6,00
5,00	16,00	60,00	5,00
6,00	8,00	40,00	6,00
	20,00	60,00	
8,00	25,00	75,00	8,00



Beringung auf Anfrage

Ring setting on request

Baguage sur demand



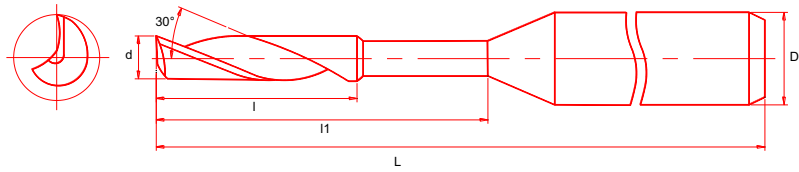
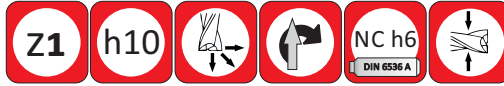

VHM
Einschneidenfräser
(RH/RC)

mit Freischliff

1 Schneide
 rechtsschneidend, ziehend

Drallwinkel: 30°

Speziell für tiefes Nutenfräsen

Solid carbide
single flute end mill
(RH/RC)

with ground recess (U/C)

1 flute
 right-hand cutting, up-cut

Helix angle: 30°

Designed for deep slot milling

Fraise à une lèvre
en carbure (RH/RC)

avec degagement

1 dent
 coupe à droite, cisailage oblique

Angle d'hélice: 30°

Pour l'usinage rainurage profond

Your Partner in MICRO MACHINING

www.axis-europe.eu
 www.axis-microtools.com

QMS ISO 9001:2008

Ø d	l	l1	L	D h6	
2,00	5,00	12,00	40,00	3,00	
			50,00	6,00	
3,00	5,00	22,00	50,00	3,00	
				6,00	
4,00	8,00	22,00	50,00	4,00	
				6,00	
5,00	14,00	22,00	50,00	6,00	
		32,00	60,00		
6,00	14,00	22,00	50,00	6,00	
		32,00	60,00		
		42,00	70,00		
8,00	14,00	32,00	60,00	8,00	
		42,00	75,00		



Beringung auf Anfrage
 Ring setting on request
 Bague sur demand



AXIS

Tools for **m**ICRO **m**ACHINING

E9211

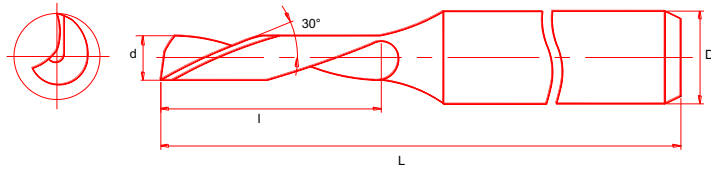
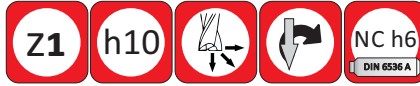
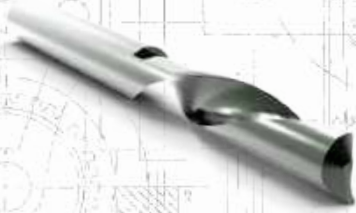

VHM
Einschneidenfräser
(LH/RC)

1 Schneide
rechtsschneidend, schiebend

Drallwinkel: 30°

Für Aluminium, weiche NE-Metalle und Plastik

Solid carbide
single flute end mill
(LH/RC)

1 flute
right-hand cutting, down-cut

Helix angle: 30°

For aluminium, soft non-ferrous materials and plastics

Fraise à une lèvre
en carbure
(LH/RC)

1 dent
coupe à droite, par poussée

Angle d'hélice: 30°

Pour aluminium, matériaux non ferreux et plastiques

Ø d	l	L	D h6	
1,00	5,00	38,00	3,00	
1,50				
2,00	8,00	38,00	3,00	
3,00				
3,00	10,00	38,00	3,00	
		50,00	6,00	
4,00	12,00	50,00	4,00	
		50,00	6,00	
5,00	14,00	60,00	6,00	
6,00		50,00		
8,00	20,00	75,00	8,00	



Beringung auf Anfrage

Ring setting on request

Baguage sur demand

Your Partner in **m**ICRO **m**ACHINING

www.axis-europe.eu
www.axis-microtools.com

QMS ISO 9001:2008



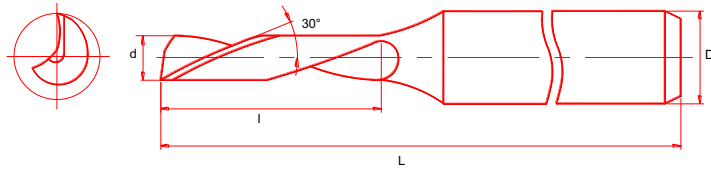
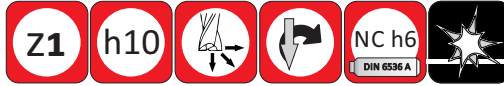

VHM
Einschneidenfräser
(LH/RC)
mit polierter Schneide

1 Schneide
 rechtsschneidend, schiebend

Drallwinkel: 30°

Für Aluminium, weiche NE-Metalle und Plastik

Solid carbide
single flute end mill
(LH/RC)
with polished flutes

1 flute
 right-hand cutting, down-cut

Helix angle: 30°

For aluminium, soft non-ferrous materials and plastics.

Fraise à une lèvre
en carbure
(LH/RC)
avec coupes polies

1 dent
 coupe à droite, par poussée

Angle d'hélice: 30°

Pour aluminium, matériaux non ferreux et plastiques

Your Partner in MICRO MACHINING

www.axis-europe.eu
www.axis-microtools.com

QMS ISO 9001:2008

Ø d	l	L	D h6	
1,00	4,00	40,00	3,00	
1,50	6,00	40,00	3,00	
2,00	3,00	50,00	3,00	
	6,00		6,00	
	8,00	40,00	3,00	
3,00	4,00	50,00	3,00	
	6,00	50,00		
	10,00	30,00		
	12,00	50,00	6,00	
	15,00	75,00	8,00	
	18,00	100,00		
4,00	5,00	50,00	4,00	
	8,00	40,00		
	14,00	50,00	6,00	
	18,00	75,00	8,00	
	20,00	60,00	4,00	
	22,00	100,00	8,00	
5,00	6,00	50,00	6,00	
	10,00	40,00		
	16,00	50,00		
	22,00	60,00	8,00	
	25,00	75,00		
	25,00	100,00		
6,00	30,00	70,00	6,00	
	7,00	50,00	6,00	
	18,00	50,00		
	20,00	60,00		
			* 40/100	
		65,00		
	25,00	75,00	8,00	
30,00	100,00			

Ø d	l	L	D h6	
6,00	40,00	80,00	6,00	
8,00	10,00	50,00	8,00	
8,00	20,00	50,00		
8,00	20,00	60,00		
8,00	20,00	* 40/100		

Ø d	l	L	D h6	
8,00	35,00	100,00	8,00	
10,00	25,00	70,00	10,00	
10,00	25,00	* 50/100		
10,00	35,00	90,00		
12,00	30,00	75,00	12,00	



Beringung auf Anfrage

Ring setting on request

Baguage sur demand

* mit Freischliff

* with ground recess (U/C)

* avec degagement



MODERNE SCHLEIFZENTREN FÜR INNOVATIVE WERKZEUGE MODERN GRINDING CENTER FOR INNOVATIVE TOOLS LE CENTRE DE MEULAGE POUR DES OUTILS INNOVATEURS



AXIS schleift auf Nano6

Die GrindSmart®Nano6 ist ein kompaktes hochtechnologisches 6-Achsen Schleifzentrum, speziell entwickelt zum Schleifen von Kleinstwerkzeugen \varnothing 0,01 mm – 2,0 mm. Es ist die erste, wahre Mikrowerkzeugschleifmaschine für die Herstellung extrem kleiner Werkzeuge in bisher noch nie erreichter Präzision was Rundlauf, Radius, Formtoleranz und Geometrie betrifft.



AXIS grinds on Nano6

The GrindSmart®Nano6 is a compact 6-axis high tech tool grinding center, designed for the manufacturing of advanced cutting tools with \varnothing 0.01 – 2.0 mm (0.0004"– 0.078"). It is the world's first true super-micro tool grinding machine for manufacturing extremely small cutting tools with the highest accuracy ever achieved in terms of concentricity, radius, shape tolerance and geometry.



AXIS produire sur Nano6.

Le centre de meulage compact 6 axes « high-tech » GrindSmart®Nano6 a été développé pour la fabrication d'outils coupants haut de gamme de 0,01 à 2,00 mm de diamètre. Il s'agit de la première machine de meulage spécifiquement conçue pour la fabrication d'outils coupants extrêmement petits. Cette machine vous permettra d'atteindre des précisions jamais atteintes en termes de concentricité, rayon, tolérance de forme et géométrie.

Wirkrichtung
Direction of cutting motion

Vorschubrichtung
Feed direction



Quelle: Rollomatic /CH





Z2

fräsen	milling	fraisage	∅		Seite / Page
VHM Micro-Schaftfräser	Solid carbide micro end mill	Mini-Fraise à en carbure	0,10 – 12,00 (RH/RC)		54
VHM Micro-Schaftfräser TiAlN beschichtet für HSC Bearbeitung	Solid carbide micro end mill TiAlN coated for HSC machining	Mini-Fraise à en carbure Revêtement: TiAlN pour l'usinage HSC	0,10 – 12,00 (RH/RC)		56
VHM ALU-Schaftfräser für den HPC-Einsatz	Solid carbide end mill (ALU) for HPC milling	Fraise (ALU) à queue cylindrique en carbure HPC	1,00 – 8,00 (RH/RC)		58
VHM ALU-Schaftfräser für den HPC-Einsatz nACRo beschichtet	Solid carbide end mill (ALU) for HPC milling nACRo coated	Fraise (ALU) à queue cylindrique en carbure HPC Revêtement: nACRo	1,00 – 8,00 (RH/RC)		59
VHM ALU-Schaftfräser mit Fischeschwanz	Solid carbide end mill (ALU) with fishtail	Fraise (ALU) à queue cylindrique en carbure bout en queue de poisson	0,30 – 6,00 (RH/RC)		59
VHM ALU-Schaftfräser mit Fischeschwanz nACRo beschichtet	Solid carbide end mill (ALU) with fishtail nACRo coated	Fraise (ALU) à queue cylindrique en carbure bout en queue de poisson Revêtement: nACRo	0,30 – 6,00 (RH/RC)		59
VHM HSC-Schaftfräser mit polierter Schneide	Solid carbide end mill HSC with polished flutes	HSC-Fraise à queue cylindrique en carbure avec coupes polies	1,50 – 8,00 (RH/RC)		60

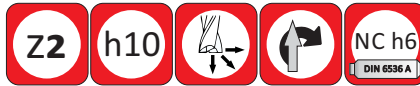

(0,1 - 3,0 mm)



(> 3,0 mm)

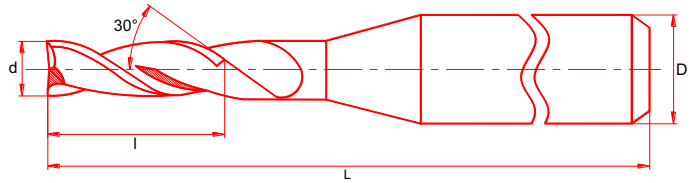

VHM
Micro-Schaftfräser
(RH/RC)

2 Schneiden
 rechtsschneidend, ziehend

Drallwinkel: 30°

Solid carbide
micro end mill
(RH/RC)

2 flutes
 right-hand cutting, up-cut

Helix angle: 30°

Mini-Fraise à
en carbure
(RH/RC)

2 dents
 coupe à droite, cisailage oblique

Angle d'hélice: 30°

Your Partner in MICRO MACHINING

www.axis-europe.eu
www.axis-microtools.com

QMS ISO 9001:2008

Ø d	l	L	D h6	
0,10	0,20	38,00	3,00	
0,20	0,40	38,00	3,00	
	0,60			
0,30	0,60	38,00	3,00	
	0,90			
0,40	0,80	38,00	3,00	
	1,20			
0,50	0,50	38,00	3,00	
	1,00			
	1,50			
0,60	1,20	38,00	3,00	
	2,00			
0,70	0,70	38,00	3,00	
	1,40			
	3,00			
0,80	1,60	38,00	3,00	
	2,40			
	3,00			
0,90	1,80	38,00	3,00	
	2,70			
1,00	1,00	38,00	3,00	
	2,00			
	3,00			
1,20	2,40	38,00	3,00	
	3,60			
1,40	2,80	38,00	3,00	
	4,20			
1,50	3,00	38,00	3,00	
	4,50			
1,60	3,20	38,00	3,00	
	4,80			
1,80	3,60	38,00	3,00	
	5,40			

∅ d	l	L	D h6	
2,00	2,00	38,00	3,00	
	4,00			
	6,00	50,00	6,00	
	7,00			
	9,00		38,00	3,00
2,50	5,00	38,00	3,00	
	7,50			
3,00	6,00	38,00	3,00	
	7,00	50,00	6,00	
	9,00	38,00	3,00	
	12,00			

∅ d	l	L	D h6	
4,00	8,00	50,00	6,00	
	12,00	50,00	4,00	
5,00	10,00	50,00	6,00	
	15,00	50,00	6,00	
6,00	12,00	50,00	6,00	
	18,00	60,00	6,00	
8,00	12,00	50,00	8,00	
	20,00	60,00	8,00	
10,00	12,00	50,00	10,00	
	22,00	75,00	10,00	
12,00	22,00	75,00	12,00	

() kurzfristig lieferbar

() delivery on short notice

() livraison sous court délai





AXIS

Tools for **m**ICRO **m**ACHINING

E9661X

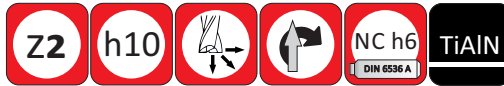

(0,1 - 3,0 mm)



(> 3,0 mm)

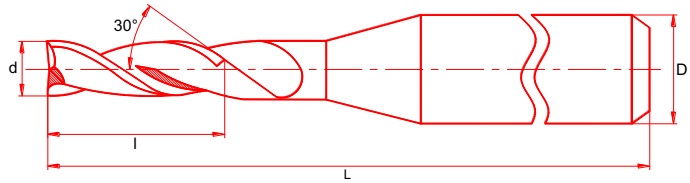

VHM
Micro-Schaftfräser
(RH/RC)

TiAlN beschichtet
für HSC Bearbeitung

2 Schneiden
 rechtsschneidend, ziehend

Drallwinkel: 30°

Solid carbide
micro end mill
(RH/RC)

TiAlN coated
for HSC machining

2 flutes
 right-hand cutting, up-cut

Helix angle: 30°

Mini-Fraise à
en carbure
(RH/RC)

Revêtement: TiAlN
pour l'usinage HSC

2 dents
 coupe à droite, cisailage oblique

Angle d'hélice: 30°

Ø d	l	L	D h6	
0,10	0,20	38,00	3,00	
0,20	0,40	38,00	3,00	
	0,60			
0,30	0,60	38,00	3,00	
	0,90			
0,40	0,80	38,00	3,00	
	1,20			
0,50	0,50	38,00	3,00	
	1,00			
	1,50			
0,60	1,20	38,00	3,00	
	2,00			
0,70	0,70	38,00	3,00	
	1,40			
	3,00			
0,80	1,60	38,00	3,00	
	2,40			
	3,00			
0,90	1,80	38,00	3,00	
	2,70			
1,00	1,00	38,00	3,00	
	2,00			
	3,00			
1,20	2,40	38,00	3,00	
	3,60			
1,40	2,80	38,00	3,00	
	4,20			
1,50	3,00	38,00	3,00	
	4,50			
1,60	3,20	38,00	3,00	
	4,80			
1,80	3,60	38,00	3,00	
	5,40			

Your Partner in mICRO **m**ACHINING

www.axis-europe.eu
 www.axis-microtools.com

QMS ISO 9001:2008

∅ d	l	L	D h6	
2,00	2,00	38,00	3,00	
	4,00			
	6,00	50,00	6,00	
	7,00			
	9,00		38,00	3,00
2,50	5,00	38,00	3,00	
	7,50			
3,00	6,00	38,00	3,00	
	7,00	50,00	6,00	
	9,00	38,00	3,00	
	12,00			

∅ d	l	L	D h6	
4,00	8,00	50,00	6,00	
	12,00	50,00	4,00	
5,00	10,00	50,00	6,00	
	15,00	50,00	6,00	
6,00	12,00	50,00	6,00	
	18,00	60,00	6,00	
8,00	12,00	50,00	8,00	
	20,00	60,00	8,00	
10,00	12,00	50,00	10,00	
	22,00	75,00	10,00	
12,00	22,00	75,00	12,00	

() kurzfristig lieferbar

() delivery on short notice

() livraison sous court délai

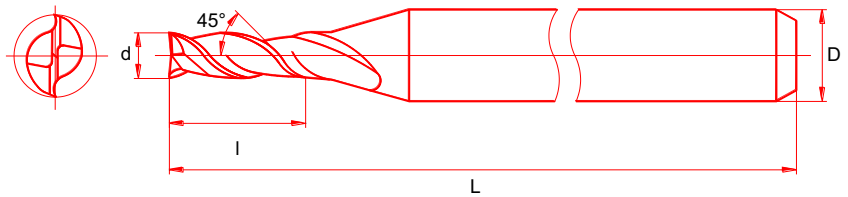
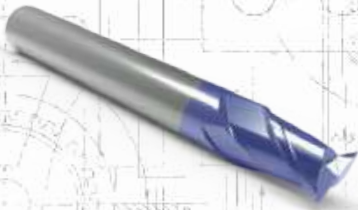

AXISTools for **m**ICRO **m**ACHINING**E8381**

VHM
Schaftfräser
für den HPC-Einsatz (RH/RC)

2 Schneiden
 rechtsschneidend, ziehend

Drallwinkel: 45°

Für Aluminium, weiche NE-
 Metalle und Plastik

E8381: unbeschichtet
 E8381N: nACRo beschichtet

Solid carbide
end mill
für HPCmilling (RH/RC)

2 flutes
 right-hand cutting, up-cut

Helix angle: 45°

For aluminium, soft non-ferrous
 materials and plastics

E8381: uncoated
 E8381N: nACRo coated

Fraise à queue cylindrique
en carbure HPC
(RH/RC)

2 dents
 coupe à droite, cisailage oblique

Angle d'hélice: 45°

Pour aluminium, matériaux non
 ferreux et plastiques

E8381: revêtement: -/
 E8381N: revêtement: nACRo

Your Partner in **m**ICRO **m**ACHINING

www.axis-europe.eu
 www.axis-microtools.com

QMS ISO 9001:2008

Ø d	l	L	D h6	€ E8381	
1,00	3,00	38,00	3,00	18,50	
1,50	4,50	38,00	3,00	18,50	
2,00	6,00	38,00	3,00	18,50	
		50,00	6,00	22,00	
3,00	9,00	38,00	3,00	18,50	
		50,00	6,00	22,00	
4,00	12,00	50,00	4,00	18,50	
			6,00	22,00	
6,00	12,00	50,00	6,00	22,00	
	18,00	60,00		24,00	
8,00	24,00	75,00	8,00	33,00	





AXIS
Tools for **mICRO mACHINING**
P8361

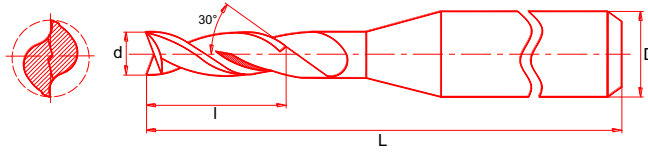
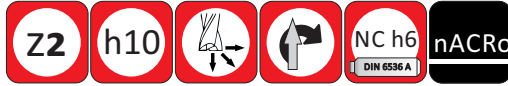

VHM
Schaftfräser
mit Fischschwanz (RH/RC)

2 Schneiden
rechtsschneidend, ziehend

Drallwinkel: 30°

Für Aluminium, weiche NE-Metalle und Plastik

E8361: unbeschichtet
E8361N: nACRo beschichtet

Solid carbide
end mill
with fishtail (RH/RC)

2 flutes
right-hand cutting, up-cut

Helix angle: 30°

For aluminium, soft non-ferrous materials and plastics.

E8361: uncoated
E8361N: nACRo coated

Fraise à queue cylindrique
en carbure bout en queue de poisson (RH/RC)

2 dents
coupe à droite, cisailage oblique

Angle d'hélice: 30°

Pour aluminium, matériaux non ferreux et plastiques

E8361: revêtement: -/
E8361N: revêtement: nACRo

Your Partner in mICRO mACHINING

www.axis-europe.eu
www.axis-microtools.com

QMS ISO 9001:2008

Ø d	l	L	D h6		
0,30	1,50	38,00	3,00		
0,40	2,00	38,00	3,00		
0,50	3,00	38,00	3,00		
0,60					
0,80	4,00	38,00	3,00		
1,00	5,00	38,00	3,00		
1,20					
1,40	6,00	38,00	3,00		
1,50					
1,60					
2,00	9,00	38,00	3,00		
2,40	10,00	38,00	3,00		
3,00	12,00	38,00	3,00		
3,00				50,00	6,00
4,00	12,00	50,00	4,00		
4,00			6,00		
4,00			4,00		
4,00	22,00	60,00	6,00		
4,00			6,00		
5,00	12,00	50,00	6,00		
6,00	12,00	50,00	6,00		
6,00	22,00	60,00			
6,00	32,00	70,00			





AXIS
Tools for **m**ICRO **m**ACHINING

E7061

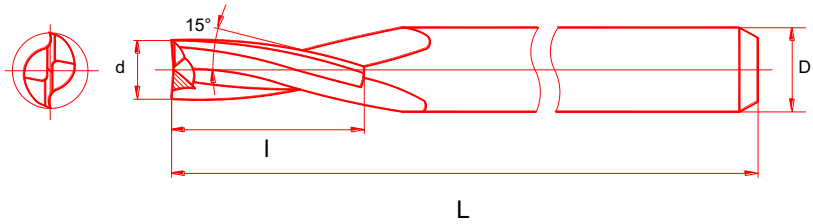
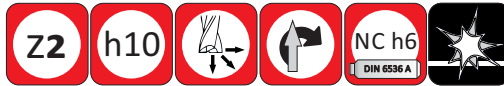

VHM
HSC-Schaftfräser
mit polierter Schneide (RH/RC)

2 Schneiden
rechtsschneidend, ziehend

Drallwinkel: 15°

für besonders hohe Vorschübe

Solid carbide
end mill HSC
with polished flutes (RH/RC)

2 flutes
right-hand cutting, up-cut

Helix angle: 15°

designed for high feed rates

HSC-Fraise à queue
cylindrique en carbure
avec coupes polies (RH/RC)

2 dents
coupe à droite, cisailage oblique

Angle d'hélice: 15°

pour des vitesses d'avance
élevées

Your Partner in mICRO mACHINING

www.axis-europe.eu
www.axis-microtools.com

QMS ISO 9001:2008

Ø d	l	L	D h6	
1,50	4,50	38,00	3,00	
2,00	6,00	38,00	3,00	
		50,00	6,00	
3,00	9,00	38,00	3,00	
		50,00	6,00	
4,00	12,00	50,00	4,00	
			6,00	
5,00	15,00	50,00	6,00	
6,00	12,00	50,00	6,00	
				18,00
8,00	24,00	75,00	8,00	





Z3

fräsen	milling	fraisage	∅		Seite / Page
VHM Micro-Schaftfräser	Solid carbide micro end mill	Mini-Fraise carbure	1,00–12,00 (RH/RC)		62
VHM Micro-Schaftfräser TiAlN beschichtet	Solid carbide micro end mill TiAlN coated	Mini-Fraise carbure Revêtement: TiAlN	1,00–12,00 (RH/RC)		63
VHM HSC-Schaftfräser mit polierter Schneide	Solid carbide end mill HSC with polished flutes	HSC-Fraise à queue cylindrique en carbure avec coupes polies	2,00–12,00 (RH/RC)		64

Z4

fräsen	milling	fraisage	∅		Seite / Page
VHM Micro-Schaftfräser mit Zentrumsschnitt	Solid carbide micro end mill with centre cut	Mini-Fraise carbure avec coupe au centre	0,20 – 12,00 (RH/RC)		65
VHM Micro-Schaftfräser mit Zentrumsschnitt TiAlN beschichtet	Solid carbide micro end mill with centre cut TiAlN coated	Mini-Fraise à carbure avec coupe au centre Revêtement: TiAlN	0,20 – 12,00 (RH/RC)		66

AXIS

Tools for **m**ICRO **m**ACHINING

E9681

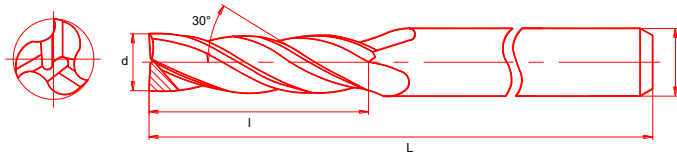
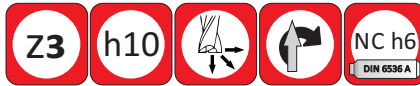
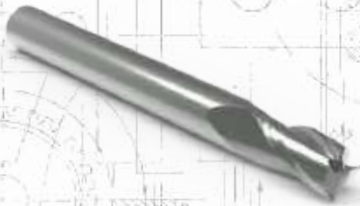

VHM
Micro-Schaftfräser
(RH/RC)

3 Schneiden
 rechtsschneidend, ziehend

Drallwinkel: 30°

Solid carbide
micro end mill
(RH/RC)

3 flutes
 right-hand cutting, up-cut

Helix angle: 30°

Mini-Fraise à
en carbure
(RH/RC)

3 dents
 coupe à droite, cisailage oblique

Angle d'hélice: 30°

Your Partner in **m**ICRO **m**ACHINING

www.axis-europe.eu
 www.axis-microtools.com

QMS ISO 9001:2008

Ø d	l	L	D h6	
1,00	3,00	38,00	3,00	
	5,00			
1,20	3,60	38,00	3,00	
	6,00			
1,40	4,20	38,00	3,00	
	7,00			
1,50	4,50	38,00	3,00	
	7,50			
1,60	4,80	38,00	3,00	
	8,00			
1,80	5,40	38,00	3,00	
	9,00			
2,00	6,00	38,00	3,00	
	7,00	50,00	6,00	
	9,00	38,00	3,00	
2,50	7,50	38,00	3,00	
	10,00			
3,00	7,00	50,00	6,00	
	9,00	38,00	3,00	
	12,00	38,00	3,00	
4,00	8,00	50,00	6,00	
	12,00		4,00	
5,00	10,00	50,00	6,00	
	15,00			
6,00	12,00	50,00	6,00	
	18,00			60,00
8,00	12,00	50,00	8,00	
	20,00			60,00
10,00	12,00	50,00	10,00	
	22,00			75,00
12,00	22,00	75,00	12,00	

() kurzfristig lieferbar () delivery on short notice () livraison sous court délai



AXIS

Tools for **m**ICRO **m**ACHINING

E9681X

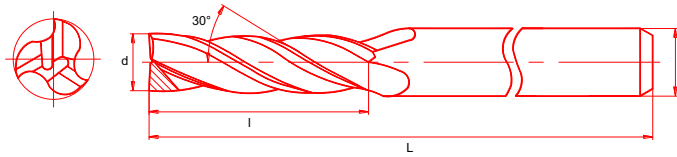
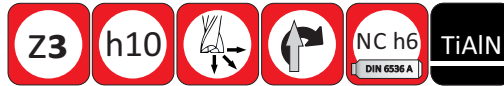

VHM
Micro-Schaftfräser
(RH/RC)

TiAlN beschichtet

3 Schneiden
 rechtsschneidend, ziehend

Drallwinkel: 30°

Für Stahl, Guss und Messing

Solid carbide
micro end mill
(RH/RC)

TiAlN coated

3 flutes
 right-hand cutting, up-cut

Helix angle: 30°

For steel, cast iron and
 Cu(Zn) alloys

Mini-Fraise à
en carbure
(RH/RC)

Revêtement: TiAlN

3 dents
 coupe à droite, cisailage oblique

Angle d'hélice: 30°

Pour acier, fonte et
 alliages Cu(Zn)

Your Partner in mICRO mACHINING

www.axis-europe.eu
 www.axis-microtools.com

QMS ISO 9001:2008

Ø d	l	L	D h6	
1,00	3,00	38,00	3,00	
	5,00			
1,20	3,60	38,00	3,00	
	6,00			
1,40	4,20	38,00	3,00	
	7,00			
1,50	4,50	38,00	3,00	
	7,50			
1,60	4,80	38,00	3,00	
	8,00			
1,80	5,40	38,00	3,00	
	9,00			
2,00	6,00	38,00	3,00	
	7,00	50,00	6,00	
	9,00	38,00	3,00	
2,50	7,50	38,00	3,00	
	10,00			
3,00	7,00	50,00	6,00	
	9,00	38,00	3,00	
	12,00	38,00	3,00	
4,00	8,00	50,00	6,00	
	12,00		4,00	
5,00	10,00	50,00	6,00	
	15,00			
6,00	12,00	50,00	6,00	
	18,00			60,00
8,00	12,00	50,00	8,00	
	20,00			60,00
10,00	12,00	50,00	10,00	
	22,00			75,00
12,00	22,00	75,00	12,00	

() kurzfristig lieferbar () delivery on short notice () livraison sous court délai



AXIS
Tools for **mICRO mACHINING**

E8681

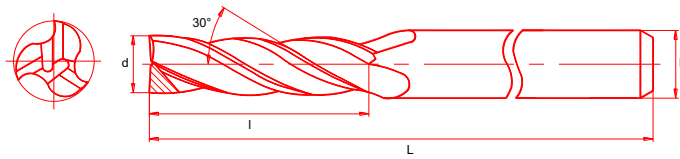
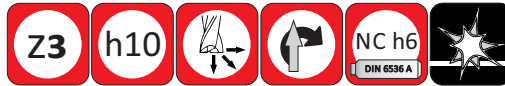

$\varnothing d$	l	L	D h6	
2,00	8,00	38,00	2,00	
4,00	10,00	38,00	4,00	
6,00	12,00	54,00	6,00	
8,00	16,00	60,00	8,00	
10,00	20,00	65,00	10,00	
12,00	24,00	75,00	12,00	

VHM
Micro-Schaftfräser
(RH/RC)

mit polierter Schneide

3 Schneiden
rechtsschneidend, ziehend

Drallwinkel: 30°

Für Aluminium, weiche NE-Metalle und Plastik

Solid carbide
micro end mill
(RH/RC)

with polished flutes

3 flutes
right-hand cutting, up-cut

Helix angle: 30°

For aluminium, soft non-ferrous materials and plastics

Mini-Fraise à
en carbure
(RH/RC)

avec coupes polies

3 dents
coupe à droite, cisailage oblique

Angle d'hélice: 30°

Pour aluminium, matériaux non ferreux et plastiques

Your Partner in mICRO mACHINING

www.axis-europe.eu
www.axis-microtools.com

QMS ISO 9001:2008

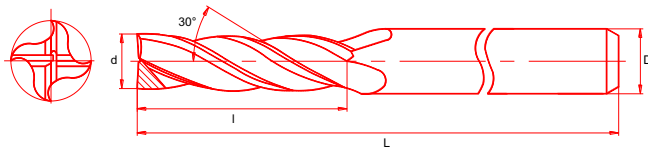
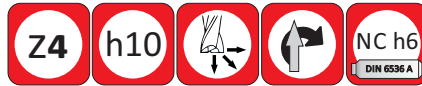
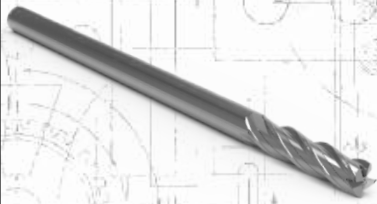

AXISTools for **m**ICRO **m**ACHINING**E9671**

VHM
Micro-Schaftfräser
mit Zentrumsschnitt (RH/RC)

4 Schneiden
 rechtsschneidend, ziehend

Drallwinkel: 30°

Solid carbide
micro end mill
with centre cut (RH/RC)

4 flutes
 right-hand cutting, up-cut

Helix angle: 30°

Mini-Fraise à
en carbure
avec coupe au centre (RH/RC)

4 dents
 coupe à droite, cisailage oblique

Angle d'hélice: 30°

Ø d	l	L	D h6	
0,20	0,60	38,00	3,00	
0,50	1,50	38,00	3,00	
1,00	3,00	38,00	3,00	
1,50	4,50	38,00	3,00	
2,00	6,00	38,00	3,00	
	7,00		6,00	
	9,00		3,00	
2,50	7,50	38,00	3,00	
3,00	7,00	50,00	6,00	
	9,00	38,00	3,00	
	12,00			
4,00	8,00	50,00	6,00	
	12,00	45,00	4,00	
	12,00	45,00	6,00	
	16,00	45,00	4,00	
5,00	10,00	50,00	6,00	
	15,00		5,00	
	15,00		6,00	
6,00	12,00	50,00	6,00	
	18,00	60,00		
8,00	20,00	60,00	8,00	
10,00	12,00	50,00	10,00	
	22,00	75,00		
12,00	22,00	75,00	12,00	

Your Partner in **m**ICRO **m**ACHINING

www.axis-europe.eu
 www.axis-microtools.com

QMS ISO 9001:2008

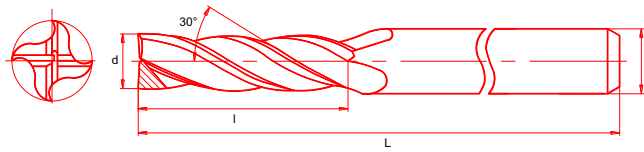
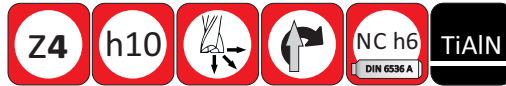

VHM
Micro-Schaftfräser
mit Zentrumsschnitt (RH/RC)

TiAlN beschichtet

4 Schneiden
 rechtsschneidend, ziehend

Drallwinkel: 30°

Für Stahl, Guss und Messing

Solid carbide
micro end mill
with centre cut (RH/RC)

TiAlN coated

4 flutes
 right-hand cutting, up-cut

Helix angle: 30°

For steel, cast iron and
 Cu(Zn) alloys

Mini-Fraise à
en carbure
avec coupe au centre (RH/RC)

Revêtement: TiAlN

3 dents
 coupe à droite, cisailage oblique

Angle d'hélice: 30°

Pour acier, fonte et
 alliages Cu(Zn)

Your Partner in MICRO MACHINING

www.axis-europe.eu
www.axis-microtools.com

QMS ISO 9001:2008

Ø d	l	L	D h6	
0,20	0,60	38,00	3,00	
0,50	1,50	38,00	3,00	
1,00	3,00	38,00	3,00	
1,50	4,50	38,00	3,00	
2,00	6,00	38,00	3,00	
	7,00		6,00	
	9,00		3,00	
2,50	7,50	38,00	3,00	
3,00	7,00	50,00	6,00	
	9,00	38,00	3,00	
	12,00			
4,00	8,00	50,00	6,00	
	12,00	45,00	4,00	
	12,00	45,00	6,00	
	16,00	45,00	4,00	
5,00	10,00	50,00	6,00	
	15,00		5,00	
	15,00		6,00	
6,00	12,00	50,00	6,00	
	18,00	60,00		
8,00	20,00	60,00	8,00	
10,00	12,00	50,00	10,00	
	22,00	75,00		
12,00	22,00	75,00	12,00	





Z2

fräsen	milling	fraisage	∅		Seite / Page
VHM Micro-Radiusfräser mit Zentrumsschnitt	Solid carbide micro ball nose end mill with centre cut	Mini-Fraise hémisphérique en carbure avec coupe au centre	0,20 – 12,00 (RH/RC)		68
VHM Micro-Radiusfräser mit Zentrumsschnitt TiAlN beschichtet	Solid carbide micro ball nose end mill with centre cut TiAlN coated	Mini-Fraise hémisphérique en carbure avec coupe au centre Revêtement: TiAlN	0,20 – 12,00 (RH/RC)		70

Z4

fräsen	milling	fraisage	∅		Seite / Page
VHM Micro-Radiusfräser mit Zentrumsschnitt	Solid carbide micro ball nose end mill with centre cut	Mini-Fraise hémisphérique en carbure avec coupe au centre	1,00 – 8,00 (RH/RC)		72
VHM Micro-Radiusfräser mit Zentrumsschnitt TiAlN beschichtet	Solid carbide micro ball nose end mill with centre cut TiAlN coated	Mini-Fraise hémisphérique en carbure avec coupe au centre Revêtement: TiAlN	1,00 – 8,00 (RH/RC)		73

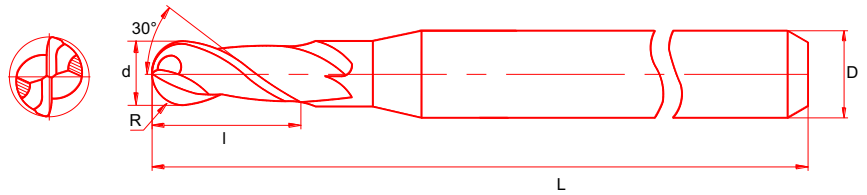
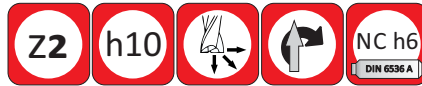
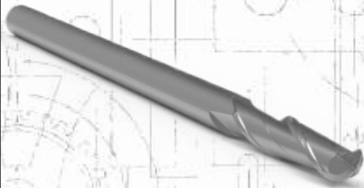
AXISTools for **m**ICRO **m**ACHINING**B9701****VHM****Micro-Radiusfräser
mit Zentrumsschnitt (RH/RC)**2 Schneiden
rechtsschneidend, ziehend

Drallwinkel: 30°

Formgenauigkeit:Radius $\pm 0,005$ (R 0,1 – R 1,5)
Radius $\pm 0,010$ (R 2,0 – R 6,0)**Solid carbide
micro ball nose end mill
with centre cut (RH/RC)**2 flutes
right-hand cutting, up-cut

Helix angle: 30°

Accuracy of shape:radius $\pm 0,005$ (R 0,1 – R 1,5)
radius $\pm 0,010$ (R 2,0 – R 6,0)**Mini-Fraise hémisphérique
en carbure avec coupe au
centre (RH/RC)**2 dents
coupe à droite, cisailage oblique

Angle d'hélice: 30°

Précision de forme:rayon $\pm 0,005$ (R 0,1 – R 1,5)
rayon $\pm 0,010$ (R 2,0 – R 6,0)

Ø d	l	L	D h6	R	
0,20	0,20	38,00	3,00	0,10	
	0,40				
0,30	0,30	38,00	3,00	0,15	
	0,60				
0,40	0,40	38,00	3,00	0,20	
	0,80				
	1,50				
0,50	0,50	38,00	3,00	0,25	
	1,00				
	1,50				
0,60	0,60	38,00	3,00	0,30	
	1,20				
	2,00				
0,70	0,70	38,00	3,00	0,35	
	1,40				
	3,00				
0,80	0,80	38,00	3,00	0,40	
	1,60				
	3,00				
0,90	0,90	38,00	3,00	0,45	
	1,80				
1,00	1,00	38,00	3,00	0,50	
	2,00				
	3,00				
	4,00				
1,20	2,40	38,00	3,00	0,60	
	3,60				
1,40	2,80	38,00	3,00	0,70	
	4,20				
1,50	3,00	38,00	3,00	0,75	
	4,50				
1,60	3,20	38,00	3,00	0,80	
	4,80				

Your Partner in **m**ICRO **m**ACHININGwww.axis-europe.eu
www.axis-microtools.com**QMS ISO 9001:2008**

∅ d	l	L	D h6	R	
1,80	3,60	38,00	3,00	0,90	
	5,40				
2,00	4,00	38,00	4,00	1,00	
	6,00		3,00		
	6,00		6,00		
2,50	5,00	38,00	6,00	1,25	
	7,50				
3,00	6,00	38,00	6,00	1,50	
	8,00	38,00	3,00		
	12,00	40,00			
	25,00	60,00			

∅ d	l	L	D h6	R	
4,00	8,00	45,00	6,00	2,00	
	12,00		4,00		
5,00	8,00	50,00	6,00	2,50	
6,00	10,00	50,00	6,00	3,00	
	16,00				
8,00	16,00	50,00	8,00	4,00	
	35,00	75,00			
10,00	22,00	70,00	10,00	5,00	
	45,00	100,00			
12,00	22,00	70,00	12,00	6,00	
	45,00	100,00			

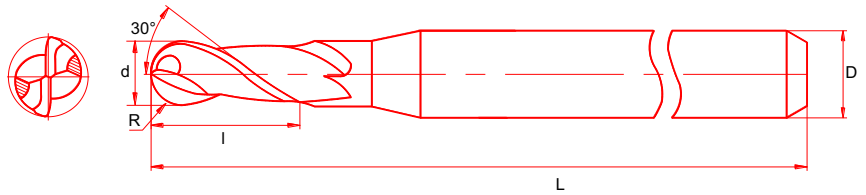
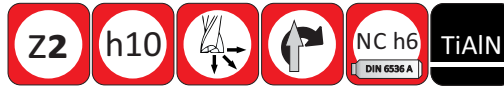

AXISTools for **m**ICRO **m**ACHINING**B9701X**

VHM
Micro-Radiusfräser
mit Zentrumsschnitt (RH/RC)

TiAlN beschichtet

2 Schneiden
rechtsschneidend, ziehend

Drallwinkel: 30°

Formgenauigkeit:

Radius $\pm 0,005$ (R 0,1 – R 1,5)
Radius $\pm 0,010$ (R 2,0 – R 6,0)

Solid carbide
micro ball nose end mill
with centre cut (RH/RC)

TiAlN coated

2 flutes
right-hand cutting, up-cut

Helix angle: 30°

Accuracy of shape:

radius $\pm 0,005$ (R 0,1 – R 1,5)
radius $\pm 0,010$ (R 2,0 – R 6,0)

Mini-Fraise hémisphérique
en carbure avec coupe au
centre (RH/RC)

Revêtement: TiAlN

2 dents
coupe à droite, cisailage oblique

Angle d'hélice: 30°

Précision de forme:

rayon $\pm 0,005$ (R 0,1 – R 1,5)
rayon $\pm 0,010$ (R 2,0 – R 6,0)

$\varnothing d$	l	L	D h6	R	
0,20	0,20	38,00	3,00	0,10	
	0,40				
0,30	0,30	38,00	3,00	0,15	
	0,60				
0,40	0,40	38,00	3,00	0,20	
	0,80				
	1,50				
0,50	0,50	38,00	3,00	0,25	
	1,00				
	1,50				
0,60	0,60	38,00	3,00	0,30	
	1,20				
	2,00				
0,70	0,70	38,00	3,00	0,35	
	1,40				
	3,00				
0,80	0,80	38,00	3,00	0,40	
	1,60				
	3,00				
0,90	0,90	38,00	3,00	0,45	
	1,80				
1,00	1,00	38,00	3,00	0,50	
	2,00				
	3,00				
	4,00				
1,20	2,40	38,00	3,00	0,60	
	3,60				
1,40	2,80	38,00	3,00	0,70	
	4,20				
1,50	3,00	38,00	3,00	0,75	
	4,50				
1,60	3,20	38,00	3,00	0,80	
	4,80				

Your Partner in **m**ICRO **m**ACHINING

www.axis-europe.eu
www.axis-microtools.com

QMS ISO 9001:2008

Ø d	l	L	D h6	R	
1,80	3,60	38,00	3,00	0,90	
	5,40				
2,00	4,00	38,00	4,00	1,00	
	6,00		3,00		
	6,00		6,00		
2,50	5,00	38,00	6,00	1,25	
	7,50				
3,00	6,00	38,00	6,00	1,50	
	8,00	38,00	3,00		
	12,00	40,00			
	25,00	60,00			

Ø d	l	L	D h6	R	
4,00	8,00	45,00	6,00	2,00	
	12,00		4,00		
5,00	8,00	50,00	6,00	2,50	
6,00	10,00	50,00	6,00	3,00	
	16,00				
8,00	16,00	50,00	8,00	4,00	
	35,00	75,00			
10,00	22,00	70,00	10,00	5,00	
	45,00	100,00			
12,00	22,00	70,00	12,00	6,00	
	45,00	100,00			





AXIS
Tools for **m**ICRO **m**ACHINING

B9721

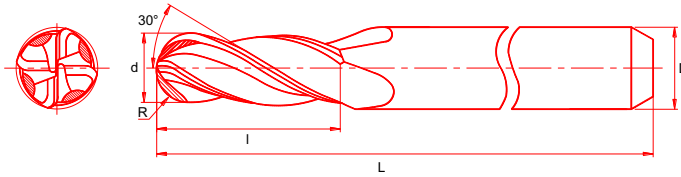
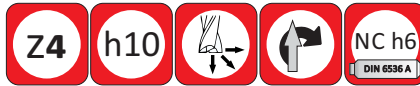

VHM
Micro-Radiusfräser
mit Zentrumsschnitt (RH/RC)

4 Schneiden
rechtsschneidend, ziehend

Drallwinkel: 30°

Formgenauigkeit:
Radius ± 0,005 (R 0,1 – R 1,5)
Radius ± 0,010 (R 2,0 – R 6,0)

Solid carbide
micro ball nose end mill
with centre cut (RH/RC)

4 flutes
right-hand cutting, up-cut

Helix angle: 30°

Accuracy of shape:
radius ± 0,005 (R 0,1 – R 1,5)
radius ± 0,010 (R 2,0 – R 6,0)

Mini-Fraise hémisphérique
en carbure avec coupe au
centre (RH/RC)

4 dents
coupe à droite, cisailage oblique

Angle d'hélice: 30°

Précision de forme:
rayon ± 0,005 (R 0,1 – R 1,5)
rayon ± 0,010 (R 2,0 – R 6,0)

Your Partner in mICRO mACHINING

www.axis-europe.eu
www.axis-microtools.com

QMS ISO 9001:2008

Ø d	l	L	D h6	R	
1,00	3,00	38,00	3,00	0,50	
1,50	4,50	38,00	3,00	0,75	
2,00	10,00	38,00	6,00	1,00	
3,00	9,00	38,00	3,00	1,50	
	12,00		6,00		
4,00	12,00	45,00	4,00	2,00	
	16,00		6,00		
5,00	10,00	50,00	5,00	2,50	
	15,00		6,00		
6,00	12,00	50,00	6,00	3,00	
	18,00				
8,00	16,00	50,00	8,00	4,00	





AXIS
Tools for **mICRO mACHINING**

B9721X

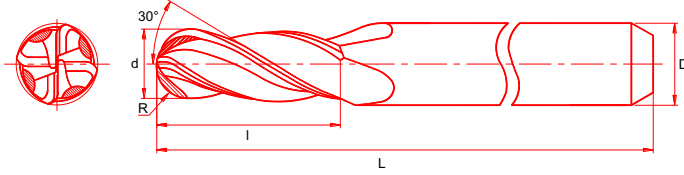
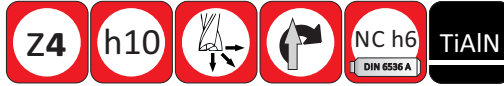

VHM
Micro-Radiusfräser
mit Zentrumsschnitt (RH/RC)
TiAlN beschichtet
4 Schneiden
rechtsschneidend, ziehend

Drallwinkel: 30°

Formgenauigkeit:
Radius ± 0,005 (R 0,1 – R 1,5)
Radius ± 0,010 (R 2,0 – R 6,0)

Solid carbide
micro ball nose end mill
with centre cut (RH/RC)
TiAlN coated
4 flutes
right-hand cutting, up-cut

Helix angle: 30°

Accuracy of shape:
radius ± 0,005 (R 0,1 – R 1,5)
radius ± 0,010 (R 2,0 – R 6,0)

Mini-Fraise hémisphérique
en carbure avec coupe au
centre (RH/RC)
Revêtement: TiAlN
4 dents
coupe à droite, cisailage oblique

Angle d'hélice: 30°

Précision de forme:
rayon ± 0,005 (R 0,1 – R 1,5)
rayon ± 0,010 (R 2,0 – R 6,0)

Your Partner in mICRO mACHINING

www.axis-europe.eu
www.axis-microtools.com

QMS ISO 9001:2008



Ø d	l	L	D h6	R	
1,00	3,00	38,00	3,00	0,50	
1,50	4,50	38,00	3,00	0,75	
2,00	10,00	38,00	6,00	1,00	
3,00	9,00	38,00	3,00	1,50	
	12,00		6,00		
4,00	12,00	45,00	4,00	2,00	
	16,00		6,00		
5,00	10,00	50,00	5,00	2,50	
	15,00		6,00		
6,00	12,00	50,00	6,00	3,00	
	18,00				
8,00	16,00	50,00	8,00	4,00	





fräsen	milling	fraisage	∅		Seite / Page
VHM Router CFK / GFK mit Fischeschwanz spiralverzahnt	Solid carbide router CFRP with fishtail chip breaker	Fraise en carbure PRFC/PRFV bout en queue de poisson avec taille en forme de "brise-copeaux"	0,80 – 3,00 (RH/RC)		76
VHM Router CFK / GFK mit Fischeschwanz spiralverzahnt Diamant beschichtet	Solid carbide router CFRP with fishtail chip breaker diamond coated	Fraise en carbure PRFC/PRFV bout en queue de poisson avec taille en forme de "brise-copeaux" Revêtement: Diamant	0,80 – 3,00 (RH/RC)		76
VHM Router CFK / GFK mit Fischeschwanz diamantverzahnt	Solid carbide router CFRP with fishtail diamond cut geometry	Fraise en carbure PRFC/PRFV bout en queue de poisson avec taille en forme de "diamant"	0,60 – 6,00 (RH/RC)		77
VHM Router CFK / GFK mit Fischeschwanz diamantverzahnt Diamant beschichtet	Solid carbide router CFRP with fishtail diamond cut geometry diamond coated	Fraise en carbure PRFC/PRFV bout en queue de poisson avec taille en forme de "diamant" Revêtement: Diamant	0,60 – 6,00 (RH/RC)		77
VHM Router CFK / GFK Verzahnung FEIN	Solid carbide router CFRP cut type fine	Fraise en carbure PRFC/PRFV Type fine	3,00 – 10,00 (RH/RC)		78
VHM Router CFK / GFK Verzahnung MITTEL	Solid carbide router CFRP cut type medium	Fraise en carbure PRFC/PRFV Type moyenne	3,00 – 10,00 (RH/RC)		79
VHM Router CFK / GFK Verzahnung GROB	Solid carbide router CFRP cut type course	Fraise en carbure PRFC/PRFV Type grossière	3,00 – 10,00 (RH/RC)		80



fräsen	milling	fraisage	∅		Seite / Page
VHM Fräser CFK / GFK gerade mit Spanbrecher	Solid carbide end mill CFRP straight flutes with chip breaker	Fraise en carbure PRFC/PRFV goujures droites avec brise-copeaux	3,00 – 10,00		81
VHM Fräser CFK / GFK Drallwinkel 10° mit Spanbrecher	Solid carbide end mill CFRP helix angle 10° with chip breaker	Fraise en carbure PRFC/PRFV Angle d'hélice 10° avec brise-copeaux	3,00 – 10,00 (RH/RC)		82
VHM Bohrfräser CFK / GFK mit geraden Radius-Spannuten	Solid carbide drill milling cutters CFRP with straight radius chip flutes	Fraise à foret en carbure PRFC/PRFV goujures droites avec brise-copeaux (rayon)	3,00 – 10,00		83
VHM Bohrfräser CFK / GFK mit geraden Radius-Spannuten Diamant beschichtet	Solid carbide drill milling cutters CFRP with straight radius chip flutes diamond coated	Fraise à foret en carbure PRFC/PRFV goujures droites avec brise-copeaux (rayon) Revêtement: Diamant	3,00 – 8,00		84

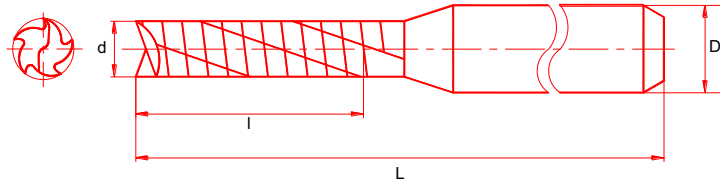

Ø d	l	L	D h6		
0,80	5,00	38,00	3,00		
1,00					
1,50					
2,00	9,00	38,00	3,00		
2,50					
3,00					

VHM Router CFK / GFK mit Fischschwanz (RH/RC)

spiralverzahnt

5 Schneiden
rechtsschneidend, ziehend

Speziell für abrasive Materialien

P7361D: Diamant beschichtet

Solid carbide router CFRP with fishtail (RH/RC)

chip breaker

5 flutes
right-hand cutting, up-cut

For machining abrasive materials

P7361D: Diamond coated

Fraise en carbure PRFC/PRFV bout en queue de poisson (RH/RC)

avec taille en forme de "brise-copeaux"

5 dents
coupe à droite, cisailage oblique

Pour l'usinage de matériaux abrasifs

P7361D: revêtement Diamant

Your Partner in MICRO MACHINING

www.axis-europe.eu
www.axis-microtools.com

QMS ISO 9001:2008

(*) Preis auf Anfrage
(*) Price on request
(*) Prix sur demande



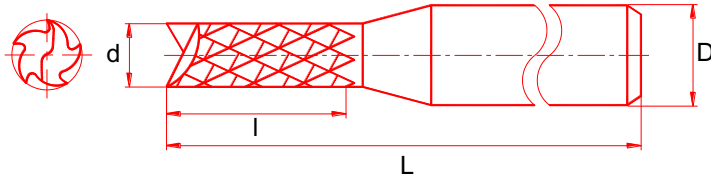
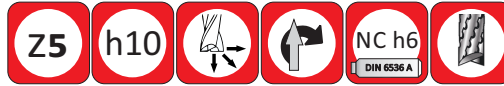

VHM
Router CFK / GFK
mit Fischschwanz (RH/RC)

diamantverzahnt

5 Schneiden
 rechtsschneidend, ziehend

Speziell für abrasive Materialien

P6361D: Diamant beschichtet

Solid carbide
router CFRP
with fishtail (RH/RC)

diamond cut geometry

5 flutes
 right-hand cutting, up-cut

For machining abrasive materials

P6361D: Diamond coated

Fraise en carbure PRFC/PRFV
bout en queue de poisson
(RH/RC)

avec taille en forme de
"diamant"

5 dents
 coupe à droite, cisailage oblique

Pour l'usage de matériaux abrasifs

P6361D: revêtement Diamant

Your Partner in MICRO MACHINING

www.axis-europe.eu
 www.axis-microtools.com

QMS ISO 9001:2008

Ø d	l	L	D h6				
0,60	3,00	38,00	3,00				
0,80	5,00	38,00	3,00				
1,00							
1,60	7,00	38,00	3,00				
	8,50						
2,00	8,50	38,00	3,00				
	9,00						
2,40	9,00	38,00	3,00				
3,00	10,50	38,00	3,00				
	12,00			50,00	6,00		
4,00	12,00	50,00	4,00				
			6,00				
4,00	22,00	60,00	4,00				
			6,00				
5,00	12,00	50,00	6,00				
6,00	12,00	50,00	6,00				
				22,00	60,00	6,00	
							32,00

(*) Preis auf Anfrage

(*) Price on request

(*) Prix sur demande





AXIS
Tools for **mICRO mACHINING**
P6401

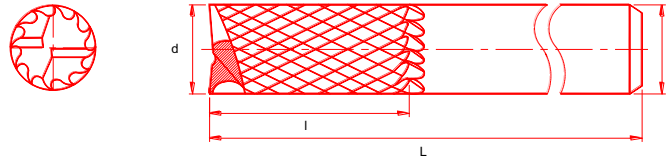
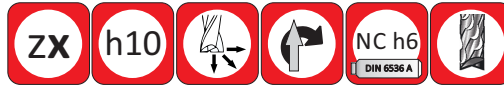

VHM
Router CFK / GFK
(RH/RC)

Verzahnung -FEIN-

Hochleistungs-Kreuzverzahnung
rechtsschneidend, ziehend

Speziell für abrasive Materialien
und faserverstärkte Kunststoffe

Solid carbide
router CFRP
(RH/RC)

Cut type -fine-

High performance diamond-
pattern
right-hand cutting, up-cut

For machining abrasive materials
and fibre-reinforced composites

Fraise en carbure
PRFC/PRFV
(RH/RC)

Type -fine-

Denture croisée hautes
performances
coupe à droite, cisailage oblique

Pour l'usinage de matériaux
abrasifs et de plastiques
renforcés de fibres.

Your Partner in mICRO mACHINING

www.axis-europe.eu
www.axis-microtools.com

QMS ISO 9001:2008

Ø d	l	L	D h6	
3,00	6,00	40,00	3,00	
	9,00			
	12,00			
	16,00	50,00	6,00	
	12,00			
	16,00			
4,00	6,00	40,00	4,00	
	10,00			
	14,00			
	18,00	50,00	6,00	
	22,00			
	12,00			
	16,00			
5,00	16,00	60,00	5,00	
	14,00	50,00	6,00	
	22,00	60,00		
6,00	14,00	50,00	6,00	
	22,00	60,00		
	32,00	70,00		
8,00	22,00	60,00	8,00	
	32,00	75,00		
10,00	32,00	75,00	10,00	

- Zwischenabmessungen auf Anfrage - mit Diamant-Beschichtung erhältlich
- Intermediate sizes on request - available with Diamond coating
- Dimensions intermédiaires sur demande - disponible avec revêtement Diamant



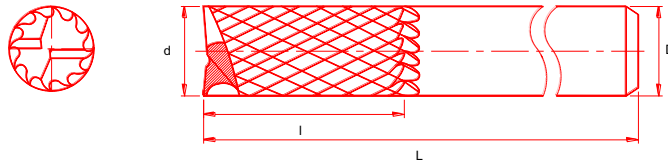
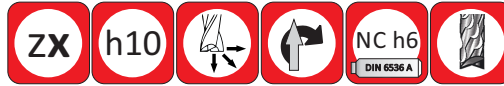

VHM
Router CFK / GFK
(RH/RC)

Verzahnung -MITTEL-

Hochleistungs-Kreuzverzahnung
 rechtsschneidend, ziehend

Speziell für abrasive Materialien
 und faserverstärkte Kunststoffe

Solid carbide
router CFRP
(RH/RC)

Cut type -medium-

High performance diamond-
 pattern
 right-hand cutting, up-cut

For machining abrasive materials
 and fibre-reinforced composites

Fraise en carbure
PRFC/PRFV
(RH/RC)

Type -moyenne-

Denture croisée hautes
 performances
 coupe à droite, cisailage oblique

Pour l'usinage de matériaux
 abrasifs et de plastiques
 renforcés de fibres

Your Partner in MICRO MACHINING

www.axis-europe.eu
 www.axis-microtools.com

QMS ISO 9001:2008

Ø d	l	L	D h6	
3,00	6,00	40,00	3,00	
	9,00			
	12,00			
	16,00	50,00	6,00	
	12,00			
4,00	16,00			
	6,00	40,00	4,00	
	10,00			
	14,00			
	18,00	50,00	6,00	
	22,00			
5,00	12,00	50,00	6,00	
	16,00			
	16,00	60,00	5,00	
6,00	14,00	50,00	6,00	
	22,00			
	32,00	70,00		
8,00	22,00	60,00	8,00	
	32,00			75,00
10,00	32,00	75,00	10,00	

- Zwischenabmessungen auf Anfrage - mit Diamant-Beschichtung erhältlich
- Intermediate sizes on request - available with Diamond coating
- Dimensions intermédiaires sur demande - disponible avec revêtement Diamant





AXIS
Tools for **mICRO mACHINING**

P6381

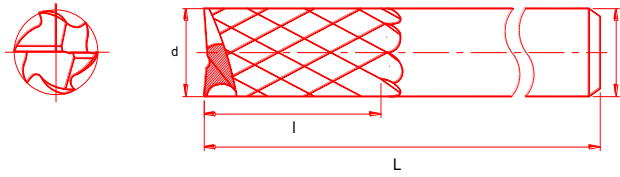
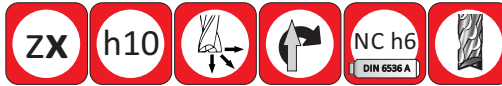

VHM
Router CFK / GFK
(RH/RC)

Verzahnung -GROB-

Hochleistungs-Kreuzverzahnung
rechtsschneidend, ziehend

Speziell für abrasive Materialien
und faserverstärkte Kunststoffe

Solid carbide
router CFRP
(RH/RC)

Cut type -course-

High performance diamond-
pattern
right-hand cutting, up-cut

For machining abrasive materials
and fibre-reinforced composites

Fraise en carbure
PRFC/PRFV
(RH/RC)

Type -grosnière-

Denture croisée hautes
performances
coupe à droite, cisailage oblique

Pour l'usinage de matériaux
abrasifs et de plastiques
renforcés de fibres

Your Partner in mICRO mACHINING

www.axis-europe.eu
www.axis-microtools.com

QMS ISO 9001:2008

Ø d	l	L	D h6	
3,00	6,00	40,00	3,00	
	9,00			
	12,00			
	16,00	50,00	6,00	
	12,00			
	16,00			
4,00	6,00	40,00	4,00	
	10,00			
	14,00			
	18,00	50,00	6,00	
	22,00			
	12,00	50,00	6,00	
	16,00			
5,00	16,00	60,00	5,00	
	14,00	50,00	6,00	
	22,00	60,00		
6,00	14,00	50,00	6,00	
	22,00	60,00		
	32,00	70,00		
8,00	22,00	60,00	8,00	
	32,00	75,00		
10,00	32,00	75,00	10,00	

- Zwischenabmessungen auf Anfrage - mit Diamant-Beschichtung erhältlich
- Intermediate sizes on request - available with Diamond coating
- Dimensions intermédiaires sur demande - disponible avec revêtement Diamant



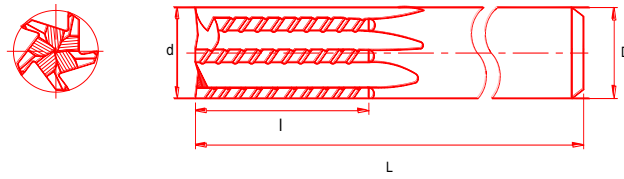

VHM
Fräser CFK / GFK

gerade mit Spanbrecher

rechtsschneidend, ziehend

Speziell für abrasive Materialien und faserverstärkte Kunststoffe

Solid carbide end mill CFRP

straight flutes with chip breaker

right-hand cutting, up-cut

For machining abrasive materials and fibre-reinforced composites

Fraise en carbure PRFC/PRFV

goujures droites avec brise-copeaux

coupe à droite, cisailage oblique

Pour l'usinage de matériaux abrasifs et de plastiques renforcés de fibres

Your Partner in **mICRO mACHINING**

www.axis-europe.eu
www.axis-microtools.com

QMS ISO 9001:2008

Ø d	l	L	D h6	
3,00	6,00	40,00	3,00	
	9,00			
	12,00			
	16,00	50,00	6,00	
	12,00			
	16,00			
4,00	6,00	40,00	4,00	
	10,00			
	14,00			
	18,00	50,00	6,00	
	22,00			
		12,00	50,00	6,00
	16,00			
5,00	16,00	60,00	5,00	
	14,00	50,00	6,00	
	22,00	60,00		
6,00	14,00	50,00	6,00	
	22,00	60,00		
	32,00	70,00		
8,00	22,00	60,00	8,00	
	32,00	75,00		
10,00	32,00	75,00	10,00	

- Zwischenabmessungen auf Anfrage - mit Diamant-Beschichtung erhältlich
- Intermediate sizes on request - available with Diamond coating
- Dimensions intermédiaires sur demande - disponible avec revêtement Diamant



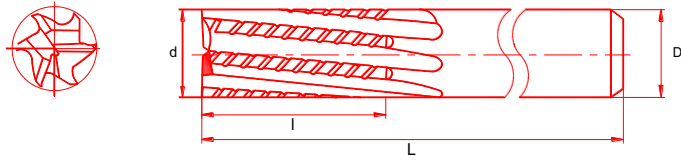

VHM
Fräser CFK / GFK
(RH/RC)

Drallwinkel 10° mit Spanbrecher

rechtsschneidend, ziehend

Speziell für abrasive Materialien
und faserverstärkte Kunststoffe

**Solid carbide
end mill CFRP
(RH/RC)**

Helix angle 10° with chip breaker

right-hand cutting, up-cut

For machining abrasive materials
and fibre-reinforced composites

**Fraise en carbure
PRFC/PRFV
(RH/RC)**

**Angle d'hélice 10° avec
brise-copeaux**

coupe à droite, cisailage oblique

Pour l'usinage de matériaux
abrasifs et de plastiques
renforcés de fibres

Your Partner in MICRO MACHINING

www.axis-europe.eu
www.axis-microtools.com

QMS ISO 9001:2008

Ø d	l	L	D h6	
3,00	6,00	40,00	3,00	
	9,00			
	12,00			
	16,00	50,00	6,00	
	12,00			
	16,00			
4,00	6,00	40,00	4,00	
	10,00			
	14,00			
	18,00	50,00	6,00	
	22,00			
	12,00			
5,00	16,00	60,00	5,00	
	14,00			
	22,00			
6,00	14,00	50,00	6,00	
	22,00			
	32,00			
8,00	22,00	60,00	8,00	
	32,00			
10,00	32,00	75,00	10,00	

- Zwischenabmessungen auf Anfrage - mit Diamant-Beschichtung erhältlich
- Intermediate sizes on request - available with Diamond coating
- Dimensions intermédiaires sur demande - disponible avec revêtement Diamant





AXIS
Tools for **mICRO mACHINING**

P6431

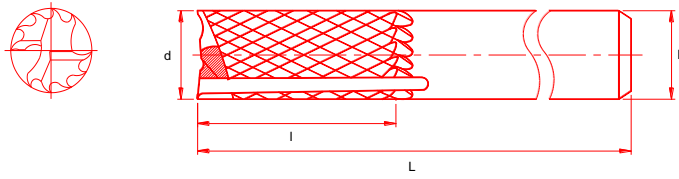
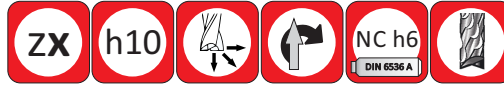

VHM
Bohrfräser CFK / GFK

mit geraden Radius-Spannuten

rechtsschneidend, ziehend

Speziell für abrasive Materialien und faserverstärkte Kunststoffe

Solid carbide
drill milling cutters CFRP

with straight radius chip flutes

right-hand cutting, up-cut

For machining abrasive materials and fibre-reinforced composites

Fraise à foret en carbure
PRFC/PRFV

goujures droites avec brise-copeaux (rayon)

coupe à droite, cisailage oblique

Pour l'usinage de matériaux abrasifs et de plastiques renforcés de fibres

Your Partner in mICRO mACHINING

www.axis-europe.eu
www.axis-microtools.com

QMS ISO 9001:2008

Ø d	l	L	D h6	
3,00	6,00	40,00	3,00	
	9,00			
	12,00			
	16,00	50,00	6,00	
	12,00			
	16,00			
4,00	6,00	40,00	4,00	
	10,00			
	14,00			
	18,00	50,00	6,00	
	22,00			
	12,00			
5,00	16,00	60,00	5,00	
	14,00			
	22,00			
6,00	14,00	50,00	6,00	
	22,00			
	32,00			
8,00	22,00	60,00	8,00	
	32,00			
10,00	32,00	75,00	10,00	

- Zwischenabmessungen auf Anfrage - mit Diamant-Beschichtung erhältlich
- Intermediate sizes on request - available with Diamond coating
- Dimensions intermédiaires sur demande - disponible avec revêtement Diamant





AXIS
Tools for **mICRO mACHINING**

P6431D

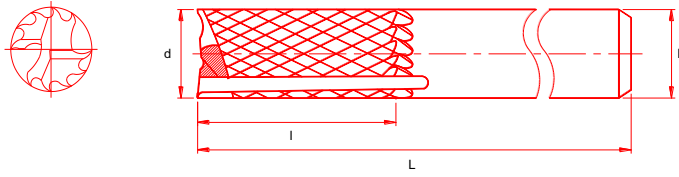

Ø d	l	L	D h6	
3	12	40	3	
4	14	50	4	
6	14	50	6	
8	22	60	8	

VHM
Bohrfräser CFK / GFK

mit geraden Radius-Spannuten

rechtsschneidend, ziehend

Speziell für abrasive Materialien und faserverstärkte Kunststoffe

Diamant beschichtet

Solid carbide
drill milling cutters CFRP

with straight radius chip flutes

right-hand cutting, up-cut

For machining abrasive materials and fibre-reinforced composites

Diamond coated

Fraise à foret en carbure
PRFC/PRFV

goujures droites avec brise-copeaux (rayon)

coupe à droite, cisailage oblique

Pour l'usinage de matériaux abrasifs et de plastiques renforcés de fibres

Revêtement Diamant

Your Partner in mICRO mACHINING

www.axis-europe.eu
www.axis-microtools.com

QMS ISO 9001:2008





gewinden	thread cutting	taroudage	∅		Seite / Page
VHM Mini-Innen-Gewindewirbelfräser TiAlN beschichtet	SC mini internal whirl thread cutter TiAlN coated	Mini fraises à tourbillonneur intérieur en carbure Revêtement: TiAlN	M0,7 – M5 (RH/RC)		86
VHM Mini-Innen-Gewindewirbelfräser mit zwei Zahnreihen TiAlN beschichtet	SC mini internal whirl thread cutter with two cutting edges TiAlN coated	Mini fraises à tourbillonneur intérieur en carbure et deux dents Revêtement: TiAlN	M1 – M10 (RH/RC)		87
entgraten	deburring	ébavurage	∅		Seite / Page
60° VHM-Entgrat-und Fasfräser (HSC) TiAlN beschichtet	60° Solid carbide deburring and chamfering mill (HSC) TiAlN coated	60° Fraise à ébavurer carbure monobloc (HSC), pour ébarber et chanfreiner Revêtement: TiAlN	3,00 – 8,00 (RH/RC)		88
90° VHM-Entgrat-und Fasfräser (HSC) TiAlN beschichtet	90° Solid carbide deburring and chamfering mill (HSC) TiAlN coated	90° Fraise à ébavurer carbure monobloc (HSC), pour ébarber et chanfreiner Revêtement: TiAlN	3,00 – 12,00 (RH/RC)		88
VHM Viertelkreisfräser Radius: +/- 0,02	SC inner radius chamfering mill radius: +/- 0,02	Fraise ¼ de cercle carbure monobloc rayon: +/-0,02	2,00 – 5,00 (RH/RC)		89

AXIS

Tools for **m**ICRO **m**ACHINING

F5001F

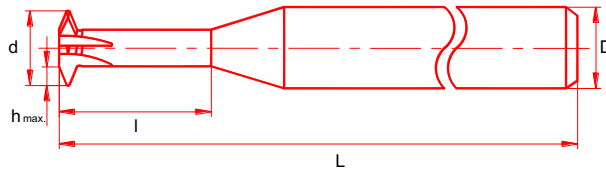

VHM Mini-Innen-Gewindewirbelfräser

2-6 Schneiden
rechtsschneidend
(M0,7 – M6)

Standardprogramm für
ISO 60° Innengewinde

Sonderausführungen
auf Anfrage lieferbar

**Solid carbide mini
internal whirl thread cutter**

2-6 flutes
right-hand cutting
(M0,7 – M6)

Standard program for
ISO 60° internals threads

Special designs on request

**Mini fraises à tourbillonneur
intérieur en carbure**

2-6 dents
coupe à droite
(M0,7 – M6)

Programme standard pour
filetage ISO60° intérieur

Fabrications spéciales
sur demande

Your Partner in **m**ICRO **m**ACHINING

www.axis-europe.eu
www.axis-microtools.com

QMS ISO 9001:2008

M 60°	h max	∅ d	l	L	Steigungsbereich range of pitch gamme de pas	D h6	Zähne flutes dents
M0,7	0,12	0,58	2,00	32,00	0,15-0,175	3,00	2
M0,8	0,14	0,62	2,30	32,00	0,20	3,00	2
M0,9	0,14	0,67	2,50	32,00	0,225	3,00	3
M1	0,17	0,74	3,00	32,00	0,20-0,25	3,00	4
M1,2	0,20	0,90	3,50	32,00	0,20-0,25-0,35	3,00	4
M1,4	0,25	1,00	3,50	32,00	0,25-0,30-0,35	3,00	4
M1,6	0,28	1,20	4,00	32,00	0,35-0,40	3,00	4
M1,8	0,33	1,35	4,00	32,00	0,35-0,40-0,45	3,00	4
M2	0,37	1,50	4,00	32,00	0,35-0,40-0,45	3,00	4
M2,5	0,40	1,90	6,00	32,00	0,40-0,45-0,50	3,00	5
M3	0,40	2,40	6,00	32,00	0,50-0,60	3,00	5
M3,5	0,50	2,80	6,00	32,00	0,50-0,60-0,70	3,00	6
M4	0,60	3,20	8,00	40,00	0,60-0,70-0,80	5,00	6
M5	0,70	4,10	9,00	40,00	0,70-0,80	5,00	6





AXIS
Tools for **mICRO mACHINING**
F5011F

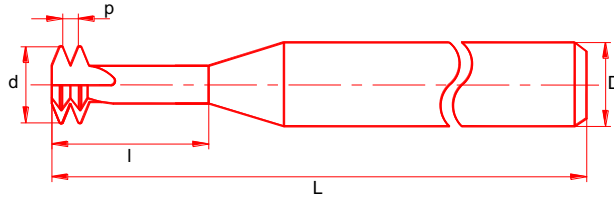

VHM Mini-Innen-Gewindewirbelfräser mit zwei Zahnreihen

3-6 Schneiden
rechtsschneidend
(M1 – M10)

Standardprogramm für
ISO 60° Innengewinde

Sonderausführungen
auf Anfrage lieferbar

Solid carbide mini internal whirl thread cutter with two cutting edges

3-6 flutes
right-hand cutting
(M1 – M10)

Standard program for
ISO 60° internals threads

Special designs on request

Mini fraises à tourbillonneur intérieur en carbure et deux dents

3-6 dents
coupe à droite
(M1 – M10)

Programme standard pour
filetage ISO60° intérieur

Fabrications spéciales
sur demande

M (p) 60°	∅ d	(l) Gewindetiefe max. thread depth max. prof. du filet max.	L	D h6	Zähne flutes dents	
M1	0,73	3,20	38,00	3,00	3	
M2	1,55	6,40	38,00	3,00	3	
M2,5	2,00	8,00	38,00	3,00	3	
M3	2,44	9,60	42,00	4,00	3	
M4	3,20	12,80	42,00	4,00	3	
M5	4,00	16,00	57,00	6,00	4	
M6	5,00	19,20	57,00	6,00	4	
M8	6,50	25,60	75,00	8,00	6	
M10	7,90	32,00	75,00	8,00	6	

Your Partner in **mICRO mACHINING**

www.axis-europe.eu
www.axis-microtools.com

QMS ISO 9001:2008



AXIS

Tools for **m**ICRO **m**ACHINING

C6741F

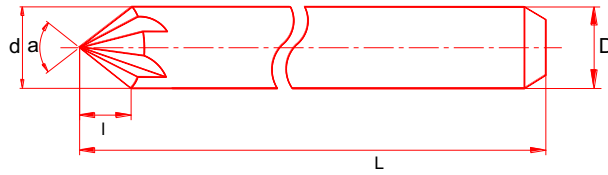
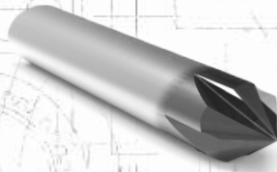

VHM-Entgrat-und Fasfräser (HSC)

TiAlN-beschichtet

4-5 Schneiden
rechtsschneidend

Spitzenwinkel (a): 60°/ 90°

Andere Ausführungen
und Zwischenabmessungen
auf Anfrage

Solid carbide deburring and chamfering mill (HSC)

TiAlN coated

4-5 flutes
right-hand cutting

Point angle (a): 60°/ 90°

Other versions and intermediate
sizes on request

Fraise à ébavurer carbure monobloc (HSC), pour ébarber et chanfreiner

Revêtement: TiAlN

4-5 dents
coupe à droite

Angle de pointe (a): 60°/ 90°

Autres variantes et dimensions
intermédiaires sur demande

Ø d	l	L	D h6	Zähne flutes dents		
3,00	3,40	40,00	6,00	4		
	1,50					
4,00	2,00	40,00	6,00	4		
6,00	5,20	40,00	6,00	4		
	3,00					
8,00	6,90	50,00	8,00	4		
	4,00					
10,00	5,00	50,00	10,00	5		
12,00	6,00	50,00	12,00	5		

Your Partner in **m**ICRO **m**ACHINING

www.axis-europe.eu
www.axis-microtools.com

QMS ISO 9001:2008





AXIS
Tools for **m**ICRO **m**ACHINING

E9611

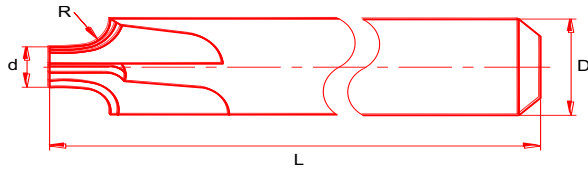
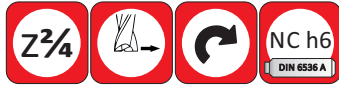

VHM-Viertelkreisfräser

2 / 4 Schneiden
rechtsschneidend

Radius: +/- 0,02

zum Abrunden und Entgraten von
Kanten mit Konturen

Auf Anfrage mit TiAlN
Beschichtung erhältlich

**SC inner radius
chamfering mill**

2 / 4 flutes
right-hand cutting

radius: +/- 0,02

for rounding and deburring
edges with contours

TiAlN coated on request

**Fraise ¼ de cercle
carbure monobloc**

2 / 4 dents
coupe à droite

rayon: +/- 0,02

pour rayonner et ébavurer les
arêtes et les contours

Revêtement: TiAlN sur demande

Your Partner in mICRO mACHINING

www.axis-europe.eu
www.axis-microtools.com

QMS ISO 9001:2008

Ø d	L	D h6	R +/- 0,02
5,00	50,00	6,00	0,50
4,00	50,00	6,00	1,00
3,00	50,00	6,00	1,50
2,00	50,00	6,00	2,00
3,00	50,00	8,00	2,50
2,00	50,00	8,00	3,00



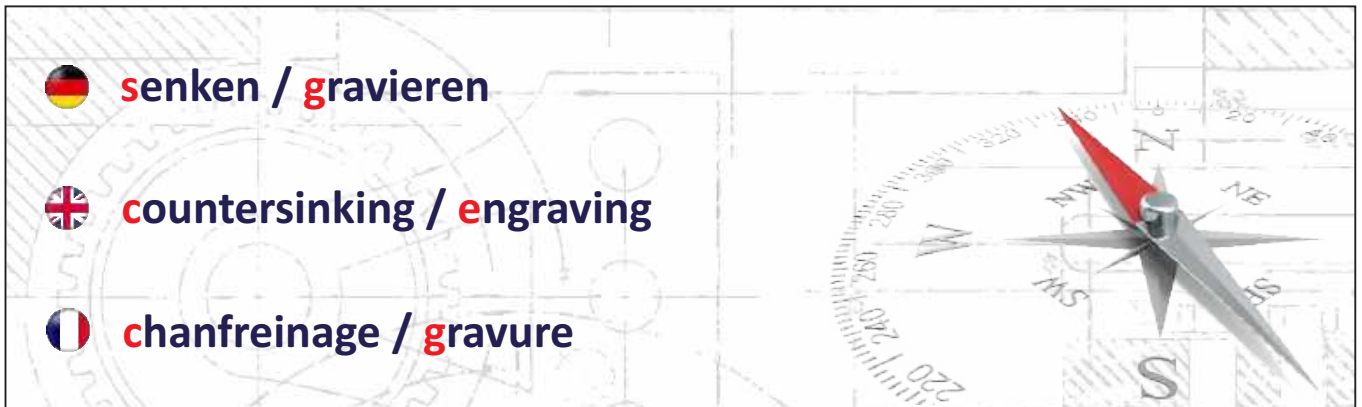

senken	countersinking	chanfreinage	∅		Seite / Page
VHM-Kegelsenker, doppelseitig: 60°/90°	SC countersinks, double-sided: 60°/90°	Fraises coniques carbure, sur les deux cotés: 60°/90°	6,00 – 12,00 (RH/RC)		91
VHM-Kegelsenker 90°/120°/140°	SC countersinks 90°/120°/140°	Fraises coniques carbure 90°/120°/140°	6,00 (RH/RC)		92

gravieren	engraving	gravure	∅		Seite / Page
Gravierstichel 15°/30°/36° 45°/60°/90°	Engraving tools 15°/30°/36° 45°/60°/90°	Burin à graver 15°/30°/36° 45°/60°/90°	2,00 – 8,00 (RH/RC)		93
Gravierfräser 30°/60°/90°	Engraving tools helix fluted 30°/60°/90°	Burin à graver avec hélice 30°/60°/90°	3,00 – 6,00 (RH/RC)		95
Gravierfräser extra fein (Isolationsgravierer) 90°	Engraving tools helix fluted Isolations engraving tool 90°	Burin à graver avec hélice (très fine) 90°	0,70 – 0,75 (RH/RC)		96
Gravierfräser kurze Ausführung (Rub-Out-Fräser) für hohen Vorschub	Engraving tool short design (Rub-Out-Cutter) for high feed	Burin à graver avec hélice version courte (Fraise „Rub-Out“) pour rapide avance	0,50 – 2,00 (RH/RC)		97
Fischschwanz-Anschliff	Fishtail	Bout en queue de poisson			



AXIS
Tools for **mICRO mACHINING**

C6731

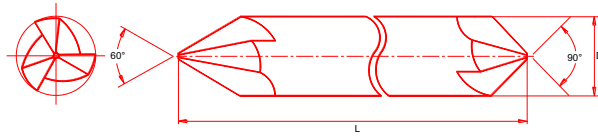
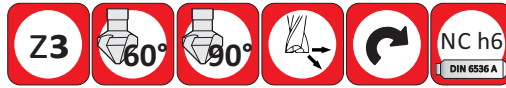

VHM-Kegelsenker, doppelseitig 60° / 90°

3 Schneiden
rechtsschneidend

zum ratterfreien Senken
und Entgraten

auf Anfrage mit TiAlN
Beschichtung erhältlich

SC countersinks, double-sided: 60° / 90°

3 flutes
right-hand cutting

for chatter-free countersinking
and deburring

TiAlN coated on request

Fraises coniques carbure, sur les deux cotés: 60° / 90°

3 dents
coupe à droite

pour un fraisage et un ébavurage
sans marques de vibrations

Revêtement: TiAlN sur demande

Your Partner in mICRO mACHINING

www.axis-europe.eu
www.axis-microtools.com

QMS ISO 9001:2008

Ø d	L	D h6	
6,00	60,00	6,00	
8,00	70,00	8,00	
10,00	75,00	10,00	
12,00	75,00	12,00	



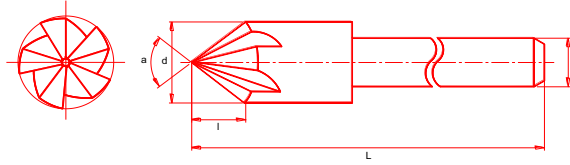

VHM-Kegelsenker
90° / 120° / 140°

5 Schneiden
 rechtsschneidend

zum ratterfreien Senken
 und Entgraten

auf Anfrage mit TiAlN
 Beschichtung erhältlich

Ø d	l	L	a	D	
6,00	3,00	38,00	90°	3,175	
6,00	1,70	38,00	120°	3,175	
6,00	1,10	38,00	140°	3,175	

SC countersinks
90° / 120° / 140°

5 flutes
 right-hand cutting

for chatter-free countersinking
 and deburring

TiAlN coated on request

Fraises coniques
carbure 90° / 120° / 140°

5 dents
 coupe à droite

pour un fraisage et un ébavurage
 sans marques de vibrations

Revêtement: TiAlN sur demande

Your Partner in MICRO MACHINING

www.axis-europe.eu
www.axis-microtools.com

QMS ISO 9001:2008



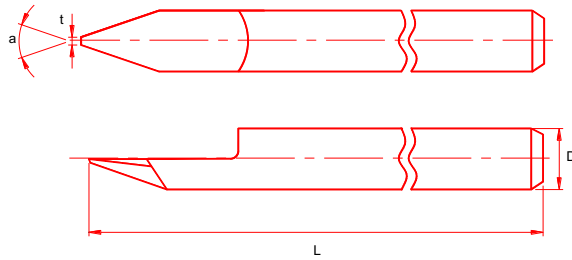

Gravierstichel

1 Schneide
rechtsschneidend

Spitzenwinkel (a):
15° ohne Höhenabstufung
30° / 36° / 45° / 60° / 90°

Spitzendurchmesser (t):
0,05 / 0,1 / 0,2 / 0,3 /
0,4 / 0,5 / 0,7

Engraving tools

1 flute
right-hand cutting

Point angle (a):
15° / 30° / 36° / 45° / 60° / 90°

Point diameter (t):
0,05 / 0,1 / 0,2 / 0,3 /
0,4 / 0,5 / 0,7

Burin à graver

1 dent
coupe à droite

Angle de pointe (a):
15° / 30° / 36° / 45° / 60° / 90°

Diamètre de pointe (t):
0,05 / 0,1 / 0,2 / 0,3 /
0,4 / 0,5 / 0,7

Your Partner in mICRO mACHINING

www.axis-europe.eu
www.axis-microtools.com

QMS ISO 9001:2008

D	Ø d (t)	L							
2,00	0,05	38,00							
	0,10								
	0,20								
3,00	0,05	38,00							
	0,10								
	0,20								
3,00	0,10	40,00							
	0,20								
	0,30								
	0,40								
	0,50								
	0,70								
3,175	0,05	38,00							
	0,10								
	0,20								
4,00	0,10	40,00							
	0,20								
	0,30								
	0,40								
	0,50								
	0,70								
4,00	0,05	50,00							
	0,10								
	0,20								
5,00	0,05	50,00							
	0,10								
	0,20								

D	t	L						
6,00	0,10	40,00						
	0,20							
	0,30							
	0,40							
	0,50							
	0,70							
	1,00							

D	t	L						
6,00	0,05	50,00						
	0,10							
	0,20							
8,00	0,05	50,00						
	0,10							
	0,20							

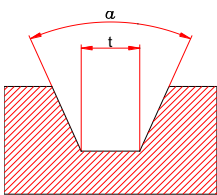

(*) auf Anfrage

(*) on request

(*) sur demande



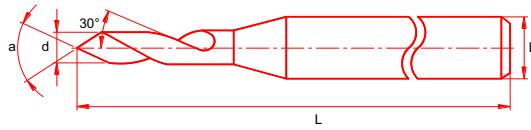

Gravierfräser

1 Schneide
rechtsschneidend

Spitzenwinkel (a):
30° / 60° / 90°

Spitzendurchmesser (t):
0,2 / 0,5 / 0,7

Andere Ausführungen
und Zwischenabmessungen
auf Anfrage

Engraving tools helix fluted

1 flute
right-hand cutting

Point angle (a):
30° / 60° / 90°

Point diameter (t):
0,2 / 0,5 / 0,7

Other versions and intermediate
sizes on request

Burin à graver avec hélice

1 dent
coupe à droite

Angle de pointe (a):
30° / 60° / 90°

Diamètre de pointe (t):
0,2 / 0,5 / 0,7

Autres variantes et dimensions
intermédiaires sur demande

Your Partner in mICRO mACHINING

www.axis-europe.eu
www.axis-microtools.com

QMS ISO 9001:2008

D	t	L			
3,00	0,20	40,00			
	0,50				
	0,70				
4,00	0,20	40,00			
	0,50				
	0,70				
6,00	0,20	40,00			
	0,50				
	0,70				



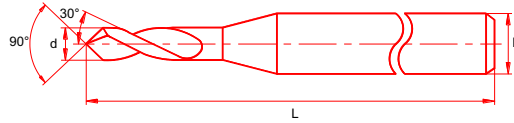

ALU < 10 % Si	ALU > 10 % Si	STEEL < 1000 N/mm ²	STEEL < 1400 N/mm ²	INOX < 850 N/mm ²	INOX > 850 N/mm ²	Ti > 850 N/mm ²	CAST GG / GGG	Cu(Zn) Au/Ag	CFRP Graphite	Plastics
-------------------------	-------------------------	--	--	--	--	--------------------------------------	-------------------------	------------------------	-------------------------	-----------------

Ø d	l	L	D	
0,70	2,00	30,00	3,00	
0,75	2,50	36,00	3,175	

VHM- Gravierfräser extra fein (Isolationsgravierer)
rechtsschneidend
Spitzenwinkel: 90°
Spitzendurchmesser: konisch zulaufend von 0,05 bis 0,7 mm

Engraving tools helix fluted extra fine (Isolations engraving tool)
right-hand cutting
Point angle: 90°
Point diameter: conical tip 0,05 to 0,7 mm

Burin à graver avec hélice très fine
coupe à droite
Angle de pointe: 90°
Diamètre de pointe: embout conique 0,05 – 0,7 mm

Your Partner in MICRO MACHINING
www.axis-europe.eu
www.axis-microtools.com
QMS ISO 9001:2008





AXIS
Tools for mICRO mACHINING
P8191

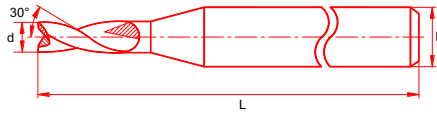

$\varnothing d$	l	L	D	
0,50	1,50	30,00	3,00	
1,00	2,50	30,00	3,00	
2,00	4,50	30,00	3,00	

VHM-Gravierfräser
kurze Ausführung
(Rub-Out-Fräser)
für hohen Vorschub

Fischschwanz-Anschliff

2 Schneiden
rechtsschneidend

4-Flächenanschliff

Solid carbide engraving tool
short design
(Rub-Out-Cutter)
for high feed

Fishtail

2 flute
right-hand cutting

4-facet pointing

Burin à graver
avec hélice en carbure
version courte
(Fraise „Rub-Out“)
pour rapide avance

Bout en queue de poisson

2 dent
coupe à droite

4 facettes

Your Partner in mICRO mACHINING

www.axis-europe.eu
www.axis-microtools.com

QMS ISO 9001:2008



dER WEG ZUM RICHTIGEN WERKZEUG
tHE WAY TO THE RIGHT TOOL
cHOISIR LE BON OUTIL



Artikel / Article	Seite / Page
B9701	68
B9701X	70
B9721	72
B9721X	73
C6731	91
C6741F	88
C6751F	88
C6811	92
D8202	20
E1231	48
E7061	60
E8211	50
E8231	46
E8381	58
E8381N	58
E8681	64
E9211	49
E9231	42
E9231D	47
E9231N	44
E9611	89
E9661	54
E9661X	56
E9671	65
E9671X	66
E9681	62
E9681X	63
F5001F	86
F5011F	87
G6451	95
G7451	95
G8441	96
G8451	95
G8471	93
P6361	77
P6361D	77
P6381	80
P6391	79

Artikel / Article	Seite / Page
P6401	78
P6411	81
P6421	82
P6431	83
P6431D	84
P7361	76
P7361D	76
P8191	97
P8361	59
P8361N	59
T1801	12
T2001	27
T2051	27
T2101	26
T2101C	26
T2101N	26
T2131F	34
T4801	11
T4811	11
T4821	11
T4901	11
T4911	11
T4921	11
T5701	10
T5801	12
T5811	12
T6401	36
T6601D	38
T6941F 10xD	32
T6941F 5xD	30
T6961	22
T6961F	24
T6981	18
T7321	13
T8321	16
T9801	28
T9851	28

Schnittrichtung
Cutting direction

Wirkrichtung
Direction of cutting

Schneidenecke
Corner

Winkel η
Cutting speed angle η

Umdrehungen je Umdrehung =
Revolutions per revolution =

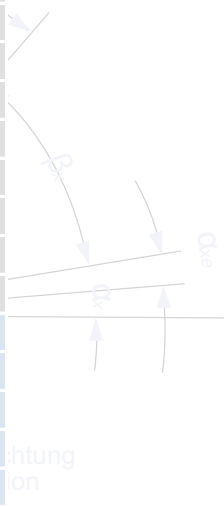

Schnittdatenempfehlung auf www.axis-europe.eu
 Cutting data recommendations on www.axis-europe.eu
 Recommandations de valeurs de coupe sur www.axis-europe.eu



Preise:

Die entsprechenden Preise und Zuschläge entnehmen Sie bitte der aktuellen Preisliste.

Allgemeine Lieferbedingungen:

Wir liefern ausschließlich zu unseren Liefer- und Zahlungsbedingungen. Diese können von uns angefordert oder unter:

www.axis-europe.eu

abgerufen werden.

Mit Herausgabe dieses Kataloges werden alle alten Unterlagen ungültig.

Druckfehler von technischen Daten berechtigen nicht zu Ansprüchen. Nachdruck auch auszugsweise, ohne unsere ausdrückliche Genehmigung ist nicht gestattet.

Prices:

For prices and surcharges please see our current price list.

General conditions of delivery:

Delivery exclusively according to our general conditions of delivery and payment. This documentation can be sent to you on request or it can be viewed at:

www.axis-europe.eu

With publication of this catalog, all old documents are now invalid. Changes reserved. Misprints of technical data do not result in entitlement to claims. Reproductions, even in extracts, are not authorised without our expressed agreement.

Prix:

Concernant les prix et suppléments veuillez voir notre liste des prix actuelle.

Conditions générales de livraison:

Livraison exclusivement suivant nos conditions générales de livraison et de paiement. Nous pouvons sur demande vous envoyer ces documents; vous pouvez également consulter ceux-ci à l'adresse:

www.axis-europe.eu

Par la publication de ce catalogue, le catalogue vieux perd sa validité. Sous réserve de modifications. Les erreurs d'impression dans les caractéristiques techniques n'ouvrent aucun droit à réclamation. Toute reproduction, même partielle, est interdite sans notre autorisation expresse.

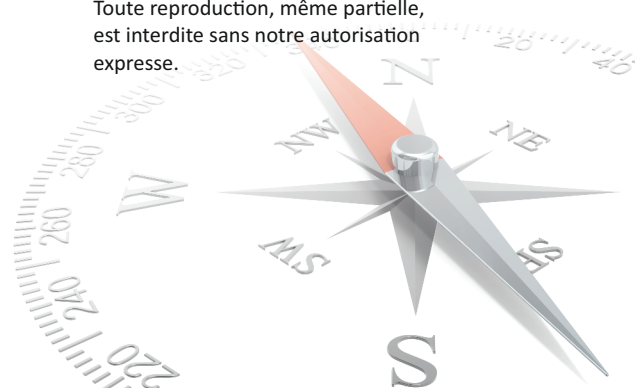

AXIS

Tools for mICRO mACHINING

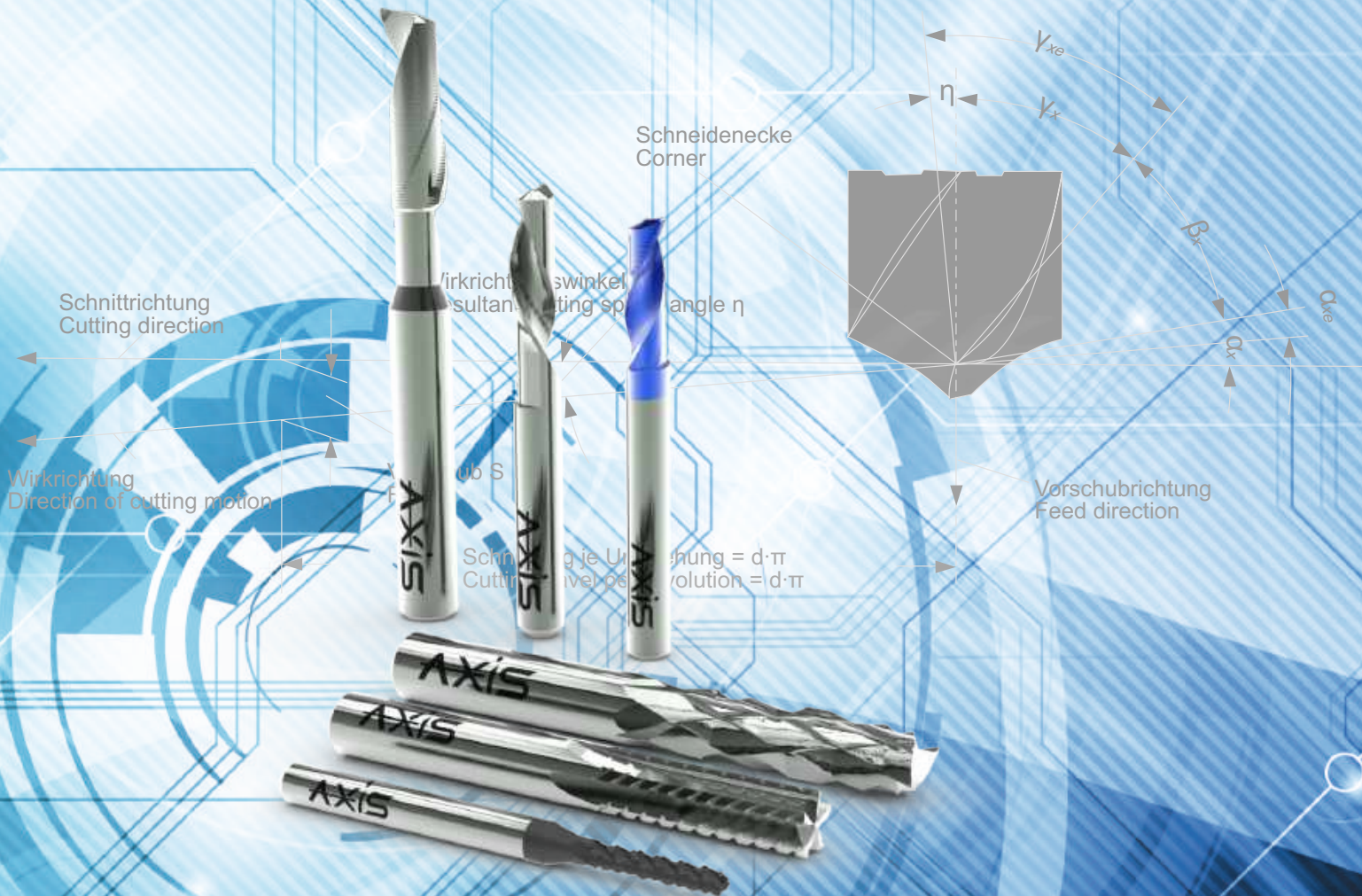

AXIS Europe GmbH
Josef-Bayer-Straße 3

D-88250 Weingarten
Germany

Tel: +49 (0) 751 560 1589 403
Fax: +49 (0) 751 560 1589 411

www.axis-europe.eu
info@axis-europe.eu

AXIS
IND-SPHINX PRECISION LTD. (Unit-B)
1, Taksal Road, Parwanoo-Kasauli Marg
Parwanoo, Himachal Pradesh
India 173220

Tel: +91 1792 232860
+91 1792 234458
Fax: +91 1792 232898

www.axis-microtools.com
info@axis-microtools.com